

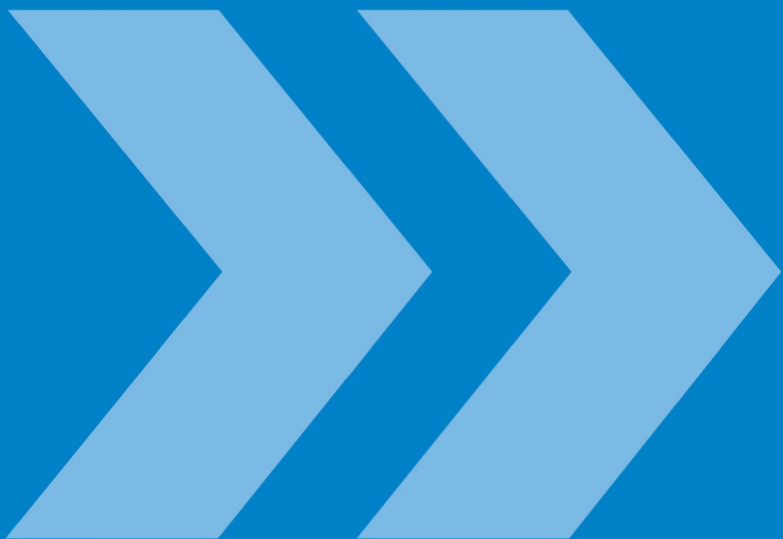

TX5951

Sentro Vortex Air Flow Sensor



TROLEX«

User Manual

TX5951 Sentro Vortex Air Flow Sensor

Contents

1. Product Overview	4	4.2 Software Menus	26
1.1 Operating Features	5	4.3 Navigation	27
1.2 Application	5	4.4 Power-up	28
1.3 Product Options	6	4.5 Main Menu	29
1.3.1 Rear Projecting Sensor	6	4.5.1 Sentro Setup	30
1.3.2 Side Projecting Sensor	6	4.5.2 Output Setup	35
1.3.3 Remote Mounted Sensor	7	4.5.3 Module Setup	44
1.4 Dimensions	8	4.5.4 Exit	54
1.4.1 Rear Projecting Sensor	8	4.6 Support	54
1.4.2 Side Projecting Sensor	10	5. Operation	55
1.4.3 Remote Mounted Sensor	11	5.1 Dual Relay Contact Output Signal	55
1.5 Technical Information	12	5.1.1 To Reset a Latched Relay	55
1.6 Electrical Details	14	6. Diagnostics and Maintenance	57
1.7 Sentro Module	15	6.1 Diagnostic Messages	57
2. Certification	16	6.2 Maintenance	58
3. Installation	18	6.2.1 Introduction	58
3.1 Tools and Test Equipment Required	18	6.2.2 Sentro Vortex - Check	59
3.2 Siting Recommendations	18	6.2.3 Sentro Vortex Sensing Probe - Clean	59
3.2.1 Fitting in Pipes and Ducts	18	6.2.4 Sentro Vortex Output Signal - Check	60
3.2.2 Fitting in Roadways and Tunnels	20	6.2.5 Sentro Vortex Sensing Probe - Calibrate	60
3.3 Orientation of the Housing	22	6.3 Disposal	61
3.4 Connections	22	6.4 Maintenance Records	61
3.4.1 0.4 to 2 V Analogue Output Signal	22	6.5 Maintenance and Calibration Log	62
3.4.2 4 to 20 mA Analogue Output Signal	22	Disclaimers	63
3.4.3 Dual Relay Contact Output Signal	22	Trademarks	63
3.4.4 RS485 Data Output Signal	22	Contact Details	63
3.4.5 Earthing	23	Document History	63
4. Setup and Calibration	24		
4.1 Controls and Indicators	24		

1. Product Overview

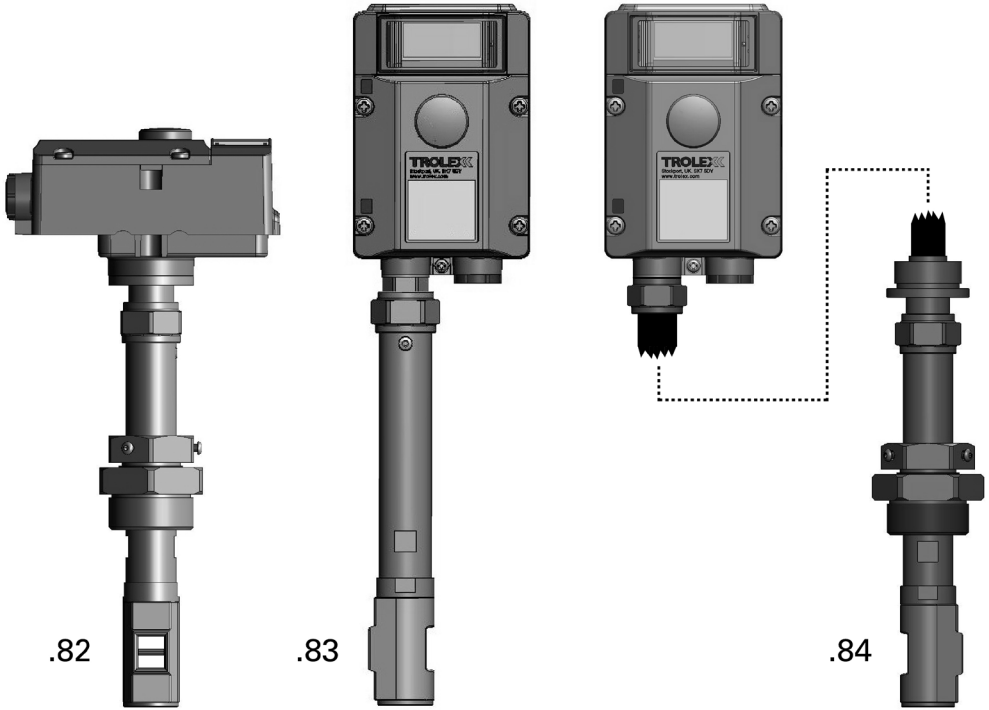

TX5951 ... 82

Sentro Vortex gas flow sensor with rear projecting sensing probe for fitting into pipe lines and ducts. Available with 1½" BSP mounting bush or specific flange plate fitting.

TX5951 ... 83

Sentro Vortex gas flow sensor with side projecting sensing probe for open flow monitoring in tunnels, roadways and process systems.

TX5951 ... 84

Sentro Vortex gas flow sensor with remote mounted sensor. For use where fitting space is limited or is difficult to access.

1.1 Operating Features

- High stability gas and air flow monitoring
- Vortex monitoring principle with no moving components
- Analogue output signal linearly proportional to flow velocity
- Integral LCD screen with large easy to read characters and back light illumination
- Programmable function and display configuration
- Choice of output signals:
 - 0.4 to 2 V
 - 4 to 20 mA
 - Dual relay contacts - can be specified normally open (NO) or normally closed (NC)
 - RS485 data output
- Rangeable flow velocity from 0.5 m/sec to 30 m/sec
- Integral LED indicators for General and High alarms

1.2 Application

Fixed point gas flow velocity measurement in pipes, ducts and open roadways. Ventilation, cooling systems and process condition monitoring in heavy duty industrial applications and hazardous areas. Analogue or digital output data linearly proportional to gas flow velocity. System supply 24 V dc.

1.3 Product Options

1.3.1 Rear Projecting Sensor

Rear Projecting Sensor With 50 mm ANSI Mounting Flange

Output	Order Reference	
	Mining Ex ia	General Purpose
0.4 to 2 V output	TX5951.01.11.82.21	N/A
4 to 20 mA output	TX5951.01.12.82.21	TX5951.03.12.82.21
Dual relay output NO	TX5951.01.14NO.82.21	TX5951.03.14NO.82.21
Dual relay output NC	TX5951.01.14NC.82.21	TX5951.03.14NC.82.21
RS485 output	TX5951.01.15.82.21	TX5951.03.15.82.21

Please specify non-standard process fittings when ordering.

Rear Projecting Sensor With 1 $\frac{1}{2}$ " BSP Mounting Bush

Output	Order Reference	
	Mining Ex ia	General Purpose
0.4 to 2 V output	TX5951.01.11.82.22	N/A
4 to 20 mA output	TX5951.01.12.82.22	TX5951.03.12.82.22
Dual relay output NO	TX5951.01.14NO.82.22	TX5951.03.14NO.82.22
Dual relay output NC	TX5951.01.14NC.82.22	TX5951.03.14NC.82.22
RS485 output	TX5951.01.15.82.22	TX5951.03.15.82.22

1.3.2 Side Projecting Sensor

Side Projecting Sensor

Output	Order Reference	
	Mining Ex ia	General Purpose
0.4 to 2 V output	TX5951.01.11.83	N/A
4 to 20 mA output	TX5951.01.12.83	TX5951.03.12.83
Dual relay output NO	TX5951.01.14NO.83	TX5951.03.14NO.83
Dual relay output NC	TX5951.01.14NC.83	TX5951.03.14NC.83
RS485 output	TX5951.01.15.83	TX5951.03.15.83

1.3.3 Remote Mounted Sensor

Remote Mounted Sensor With 50 mm ANSI Mounting Flange

Output	Order Reference	
	Mining Ex ia	General Purpose
0.4 to 2 V output	TX5951.01.11.84.21	N/A
4 to 20 mA output	TX5951.01.12.84.21	TX5951.03.12.84.21
Dual relay output NO	TX5951.01.14NO.84.21	TX5951.03.14NO.84.21
Dual relay output NC	TX5951.01.14NC.84.21	TX5951.03.14NC.84.21
RS485 output	TX5951.01.15.84.21	TX5951.03.15.84.21

Please specify cable length and non-standard process fittings when ordering.

Remote Mounted Sensor With 1 1/2" BSP Mounting Bush

Output	Order Reference	
	Mining Ex ia	General Purpose
0.4 to 2 V output	TX5951.01.11.84.22	N/A
4 to 20 mA output	TX5951.01.12.84.22	TX5951.03.12.84.22
Dual relay output NO	TX5951.01.14NO.84.22	TX5951.03.14NO.84.22
Dual relay output NC	TX5951.01.14NC.84.22	TX5951.03.14NC.84.22
RS485 output	TX5951.01.15.84.22	TX5951.03.15.84.22

Please specify cable length when ordering.

Checkpoint

Please specify the probe length required when ordering your **Sentro Vortex**. Probes available from 160 mm to 2000 mm insertion length in 100 mm increments.

Checkpoint

The 0.4 to 2 V output version of **Sentro Vortex** is only available as Group 1.

1.4 Dimensions

1.4.1 Rear Projecting Sensor

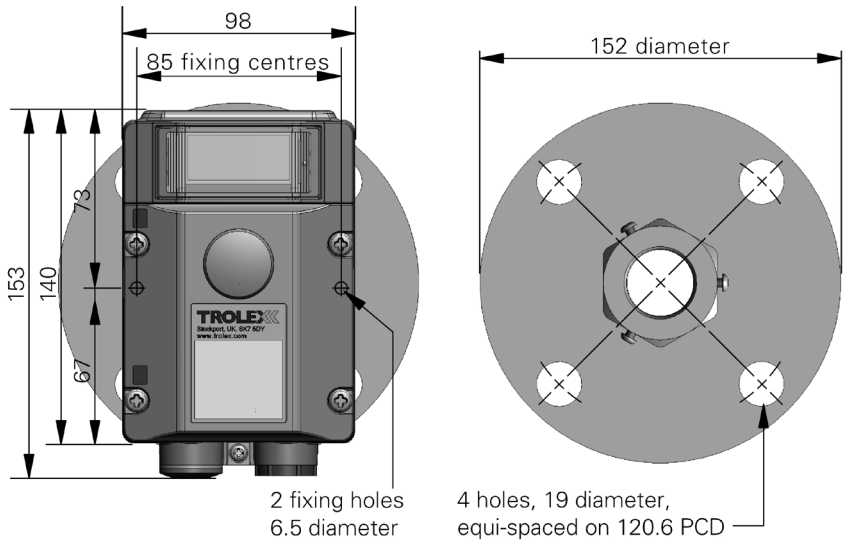
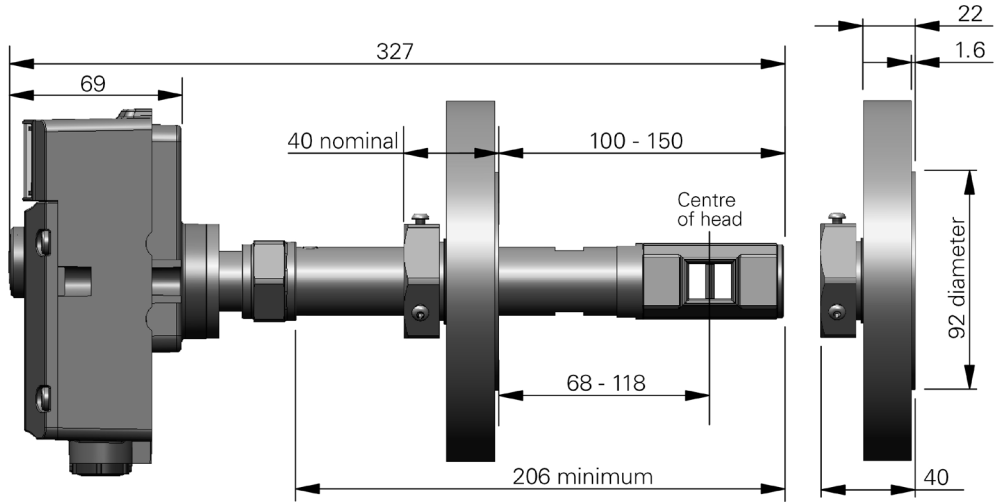

All dimensions in mm

Probes available from 160 to 2000 mm insertion length in 100 mm increments

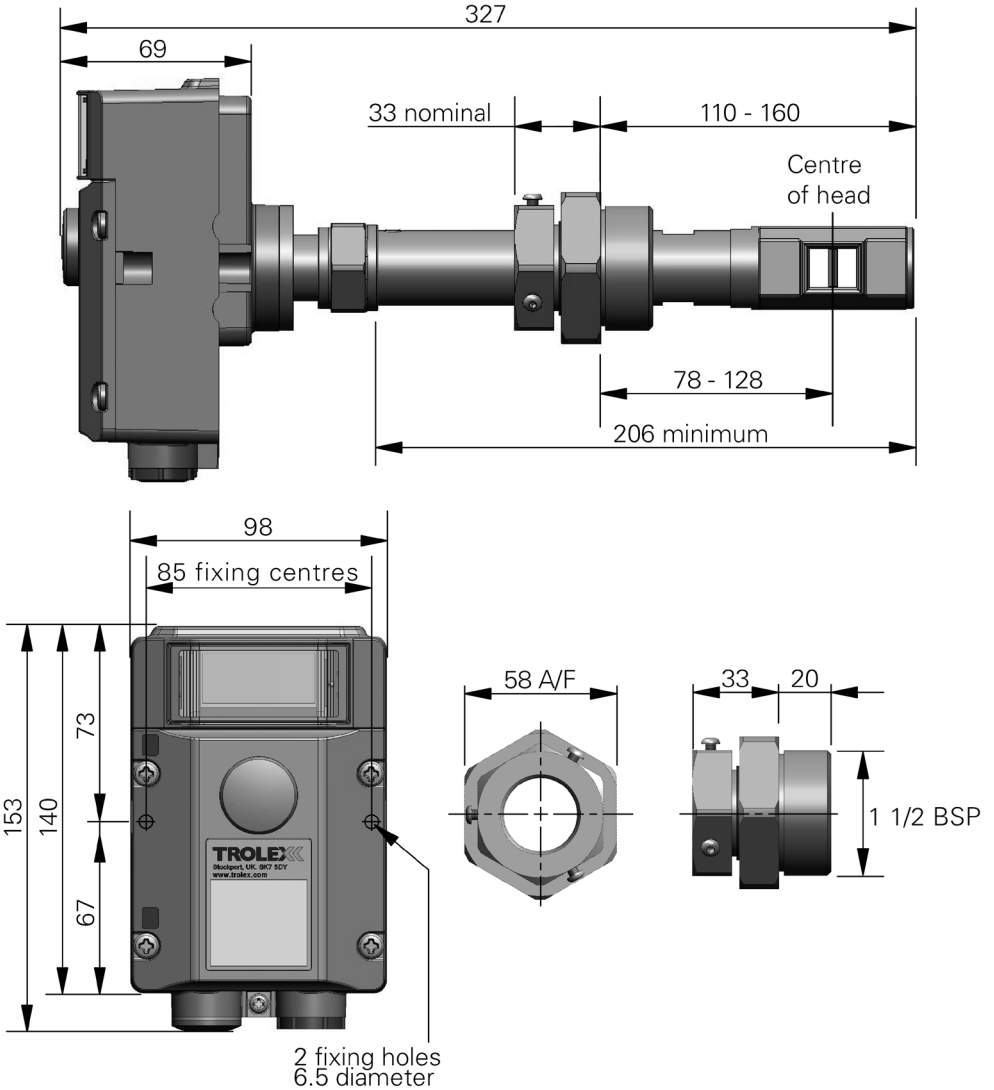

All dimensions in mm

Probes available from 160 to 2000 mm insertion length in 100 mm increments

1.4.2 Side Projecting Sensor

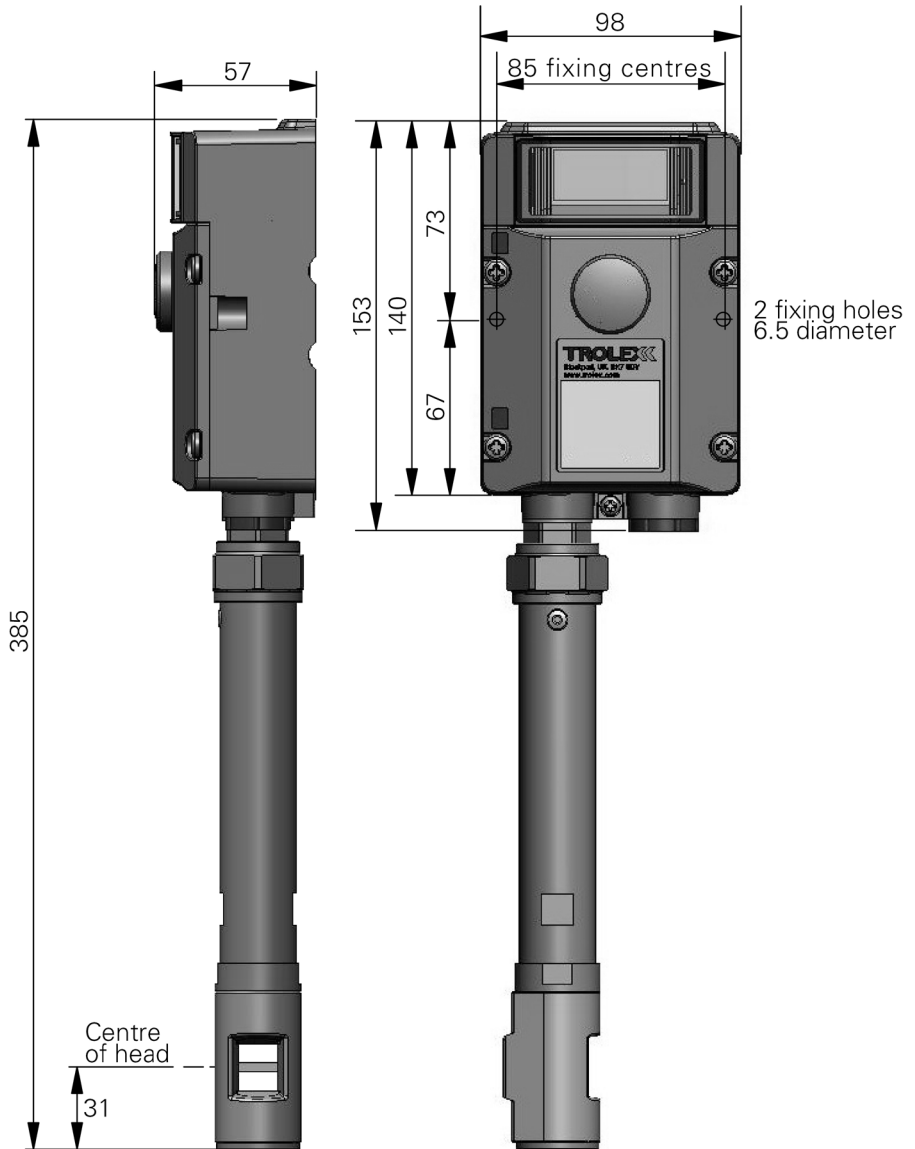

All dimensions in mm

Probes available from 160 to 2000 mm insertion length in 100 mm increments

1.4.3 Remote Mounted Sensor

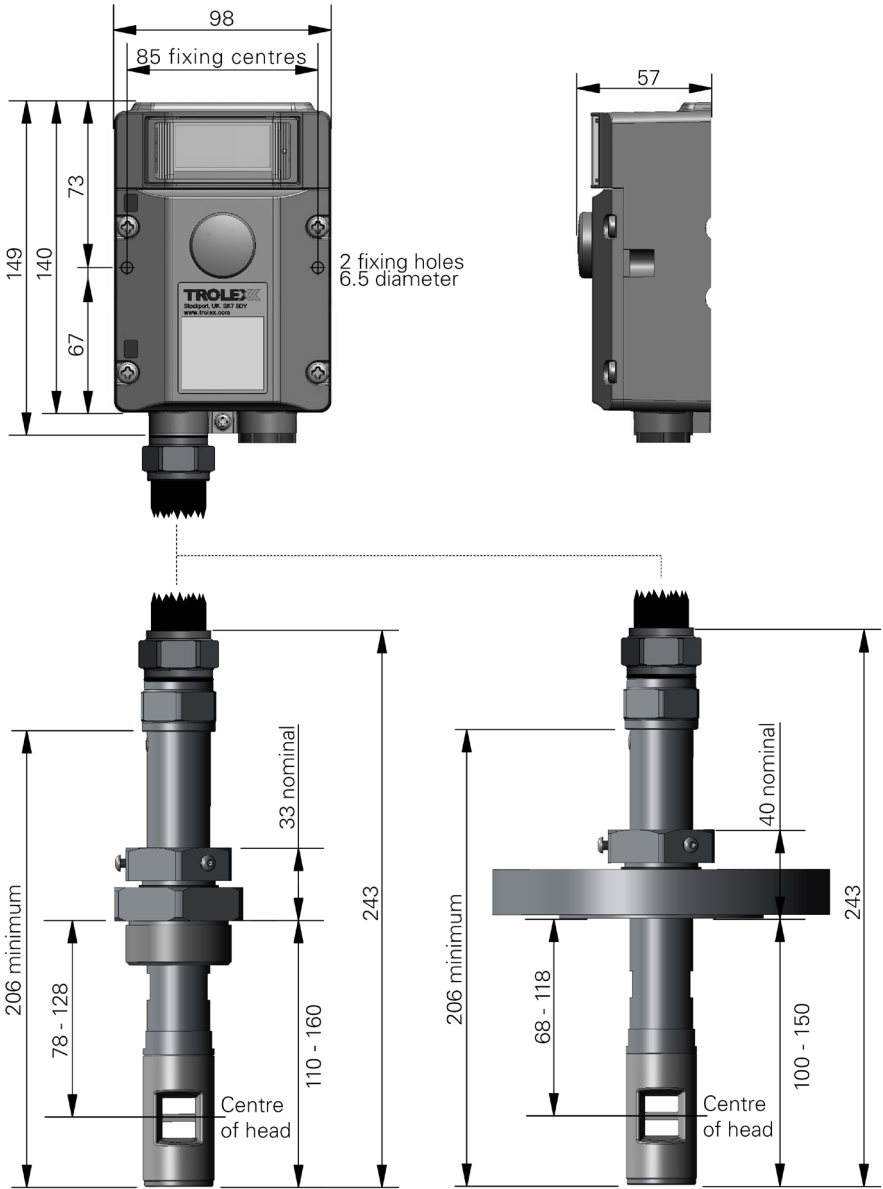

All dimensions in mm
 Probes available from 160 to 2000 mm insertion length in 100 mm increments

1.5 Technical Information

Flow measuring range	Rangeable from 0.5 to 5 m/s up to 0.5 to 30 m/s
Accuracy	+/- 2% within 12.5° rotation of flow axis
Linearity	+/- 1%
Ambient temperature limits	-15°C to +50°C
Sensor temperature limit	-20°C to +150°C
Humidity	0 to 95% non-condensing
Protection classification	Dust and waterproof to IP65
Process media	Gas, air, steam or saturated vapour
Housing material	Reinforced polymer
Sensor material	Stainless steel - grade 316
Flexible cable (remote sensor)	PVC coated armoured flexible conduit
Maximum static pressure	20 bar
Process fittings	<ul style="list-style-type: none">• 1½" BSP mounting bush• 50 mm ANSI mounting flange
Cable entry	<ul style="list-style-type: none">• Rear projecting sensing probe - 2 x M20• Side projecting sensing probe - 1 x M20• Remote mounted sensing probe - 1 x 2M20
Nett weight	<ul style="list-style-type: none">• Rear projecting sensing probe - 1.5 kg• Side projecting sensing probe - 1.5 kg• Remote mounted sensing probe - 2.5 kg
Information display	128 x 64 dot graphic backlit LCD screen
Vibration limits	Vibration limits (EN 60079-29-1): <ul style="list-style-type: none">• 10 to 30 Hz - 1.00 mm total excursion• 31 to 150 Hz - 19.6 m/s² acceleration peak
Impact limits	20 joules (housing)
Output Signals	<ul style="list-style-type: none">• 0.4 to 2 V• 4 to 20 mA• Dual relay contact• RS485 data

Alarms	Programmable General and High alarm levels with LED indicators
Menu configuration	<ul style="list-style-type: none">• Security code protection• Scale factor selection (linear/volume/time)• Setpoint level and mode adjustment• Data output protocol configuration• Flow units selection• Duty display text entry
Fault indication	<ul style="list-style-type: none">• Loss of communications• Sensing module absent• Sensor over-range

1.6 Electrical Details

0.4 to 2 V Output Signal

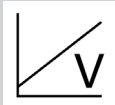

Supply voltage	Group 1	11 to 14.4 V dc
Max line voltage	Group 1	10 R at 12 V dc
Supply current		40 mA

4 to 20 mA Output Signal

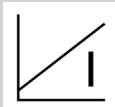

Supply voltage	Group 1	10 to 14 V dc
	General Purpose	18 to 28 V
Max line voltage	Group 1	220 R at 12 V dc
	General Purpose	500 R at 24 V dc
Supply current		40 mA

Dual Relay Output Signal

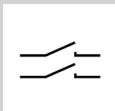

Supply voltage	Group 1	10 to 14 V dc
	General Purpose	20 to 28 V
Contact rating	Group 1	5 A at 230 V dc
	General Purpose	5 A at 230 V dc
Supply current		45 mA

RS485 Data Output

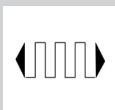

Supply voltage	Group 1	10 to 14 V dc
	General Purpose	14 to 28 V dc
Data protocol		RS485 Modbus
Supply current		40 mA

1.7 Sentro Module

Plug-in pre-calibrated sensing module with standardised output data.

- The sensing module stores all the necessary data about its type identification, sensing range and specific calibration. This data is automatically recognised by **Sentro Vortex** when the sensing module is loaded into the module bay
- The sensing modules are pre-calibrated so they can be replaced at any time by a replacement sensing module
- The sensing module will identify itself when plugged into the sensor housing and auto configuration will take place
- All Sentro sensing modules have two output alarm signals for General alarm and High alarm. Default values are entered during manufacture and these can be changed to preferred values
- The two alarm signals can be set to illuminate built-in flashing LED indicators
- The two alarm signals can be set to operate the General alarm and High alarm relays on the Contact Output version of **Sentro Vortex**

2. Certification

Pending

3. Installation

3.1 Tools and Test Equipment Required

No special tools are required:

- Metric spanner set
- Metric hexagon key set
- Standard electrical test meter

Checkpoint

Where the process cannot be interrupted to remove the **Sentro Vortex** from a pipeline, an isolating ball valve may be fitted to the process connection at the installation. This is also useful in installations that have a high level of contamination or moisture in the gas stream. Build up of debris or water vapour will cause deterioration of the output signal.

3.2 Siting Recommendations

3.2.1 Fitting in Pipes and Ducts

To attain the best accuracy of response, select a position that is at least twenty pipe diameters down-stream from bends or obstructions, and approximately five pipe diameters from down-stream intrusions.

Similarly, the sensor should be mounted at least fifteen pipe diameters from a pipe reducer and fifty pipe diameters from valves.

If this is not possible then the installation of a standard flow straightener will improve performance.

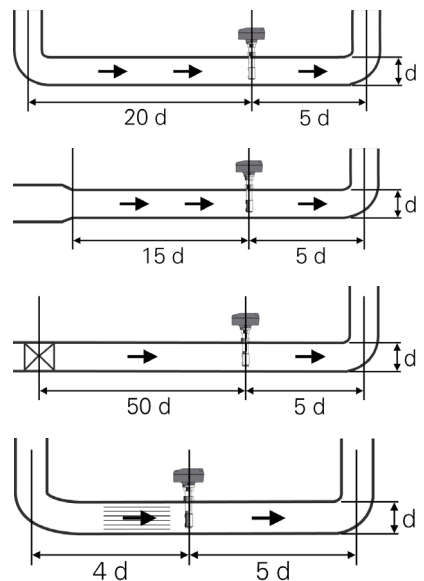

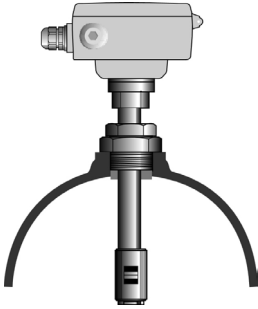

Fit a corresponding threaded boss or flange at the monitoring point and install the sensor, ensuring a gas tight seal.

Checkpoint

High pressure versions, above 2 bar, will be supplied with a welded bush or flange and will require dedicated process fittings.

Release the clamping ring on the mounting bush or flange.

The centre of the flow path of the sensing head should be positioned as shown.

Checkpoint

Ensure that pressurised systems have been completely vented before installation or removal of the sensor.

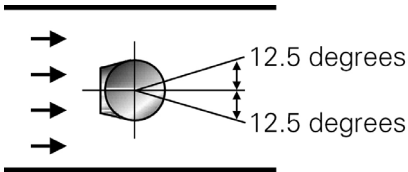
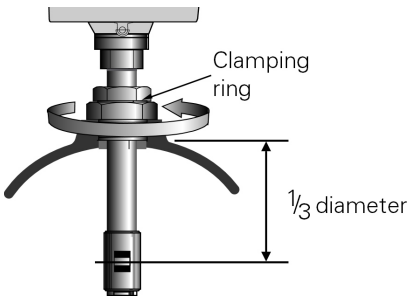

Position the sensing head with the smaller opening facing the flow, within a rotational deviation of no more than 12.5° from the axis of flow.

Tighten the clamping ring with moderate force.

Avoid fitting the sensor at low points in pipework structures to prevent the sensing head from being affected by large accumulations of moisture.



3.2.2 Fitting in Roadways and Tunnels

To attain the best accuracy of response, select a position away from adjacent structures with a clearance of 200 mm.

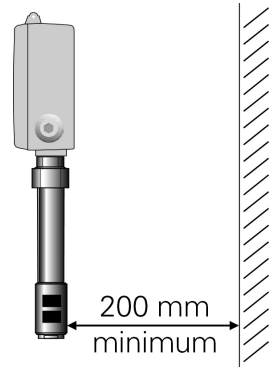

The version with a side projecting sensor can be mounted on to a suitable support using the mounting holes.



Alternatively use a standard mounting bush or flange for fitting to a suitable bracket.

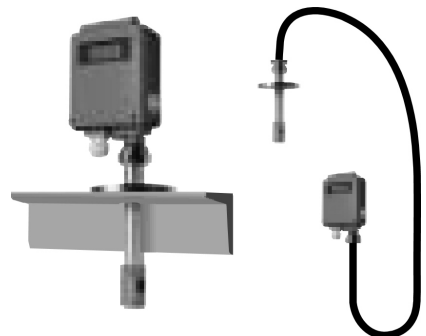

3.3 Orientation of the Housing

The housing of the **Sentro Vortex** can be turned to any position about the axis of the sensing probe and locked in position for the preferred mounting attitude or cable routing access.

Release the locking ring by turning anti-clockwise as far as it will go.

Rotate the sensing probe or the sensor housing to the desired position.

Checkpoint

Rotation is limited to approximately 300° so do not force the housing beyond the limit stops.

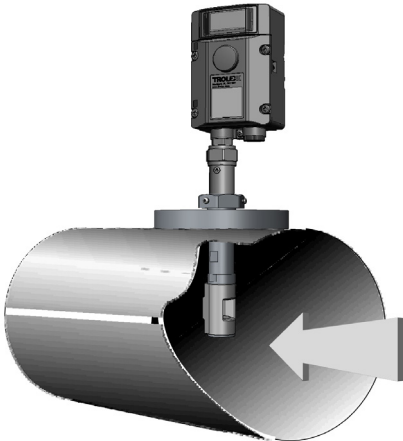
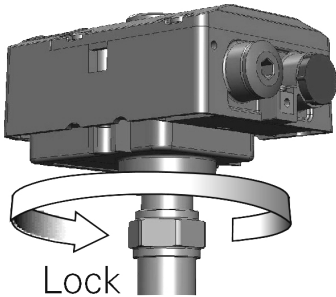
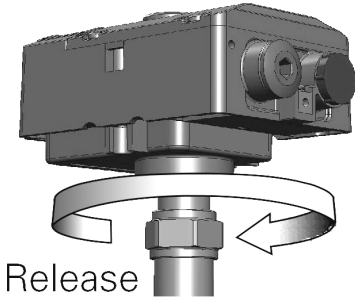

3.4 Connections

3.4.1 0.4 to 2 V Analogue Output Signal

The output signal from terminals 1 and 2 is a low impedance two-wire voltage output.

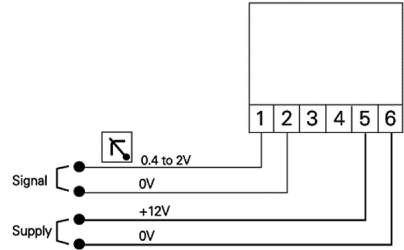

3.4.2 4 to 20 mA Analogue Output Signal

The output signal from terminals 1 and 2 is a conventional 4 to 20 mA two wire current regulated signal loop.

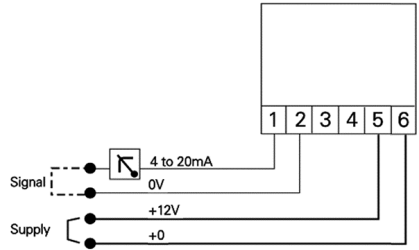

3.4.3 Dual Relay Contact Output Signal

Dual independent output contacts for remote signalling and control. Setpoint values for General and High alarms may be adjusted to preference.

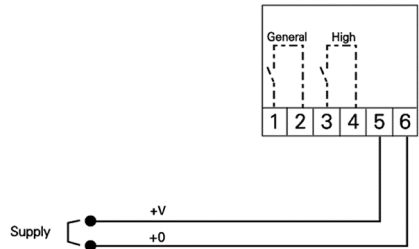

3.4.4 RS485 Data Output Signal

RS485 serial data output with analogue signal intelligence.

Use in conjunction with a PC for data display and setpoint alarm warnings.

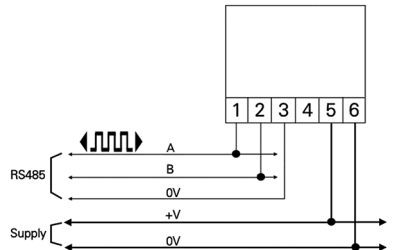

Up to 32 sensors acting as slaves can

32 node RS485 (MODBUS)

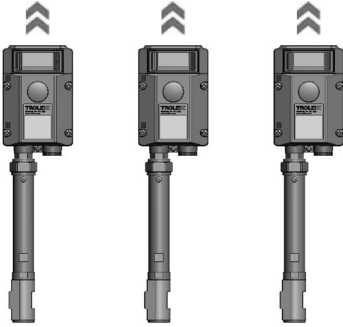

communicate with the master unit on a single data cable.

The address code of the sensor is marked on the duty label of the sensor.

Physical layer:	RS485
Protocol:	Troxel proprietary
Connection mode:	Modbus
Number of points:	32
Maximum distance:	1,000 m



Recommended cable (specified in BS5308 Part 1) for locally powered sensors:

- 1 twisted pair
- 0.5 mm²
- Overall screen

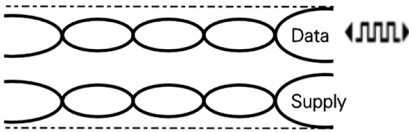

Recommended cable for sensors that are powered through the data cable:

- 2 twisted pair
- 0.5 mm²
- Individual/overall screen

3.4.5 Earthing

Take care to ensure correct earthing procedures are followed during installation.

Because of its high response sensitivity, the **Sentro Vortex** can be affected by earth borne electrical interference, where associated metal structures have not been properly earthed.

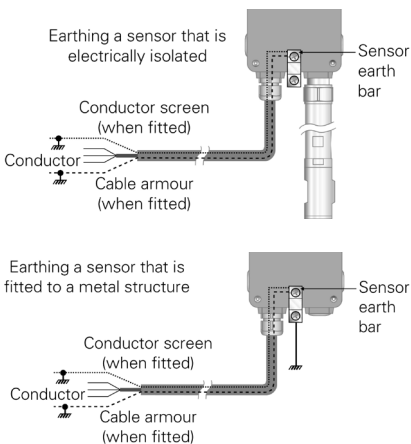

4. Setup and Calibration

4.1 Controls and Indicators

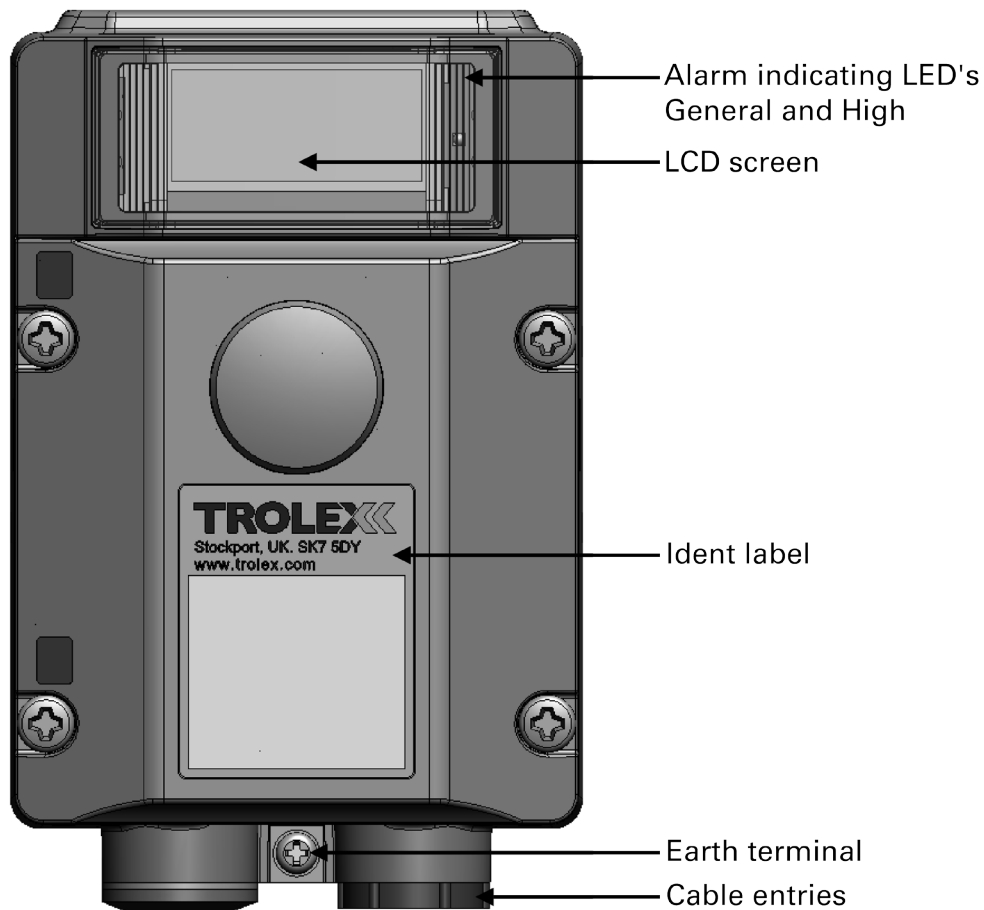

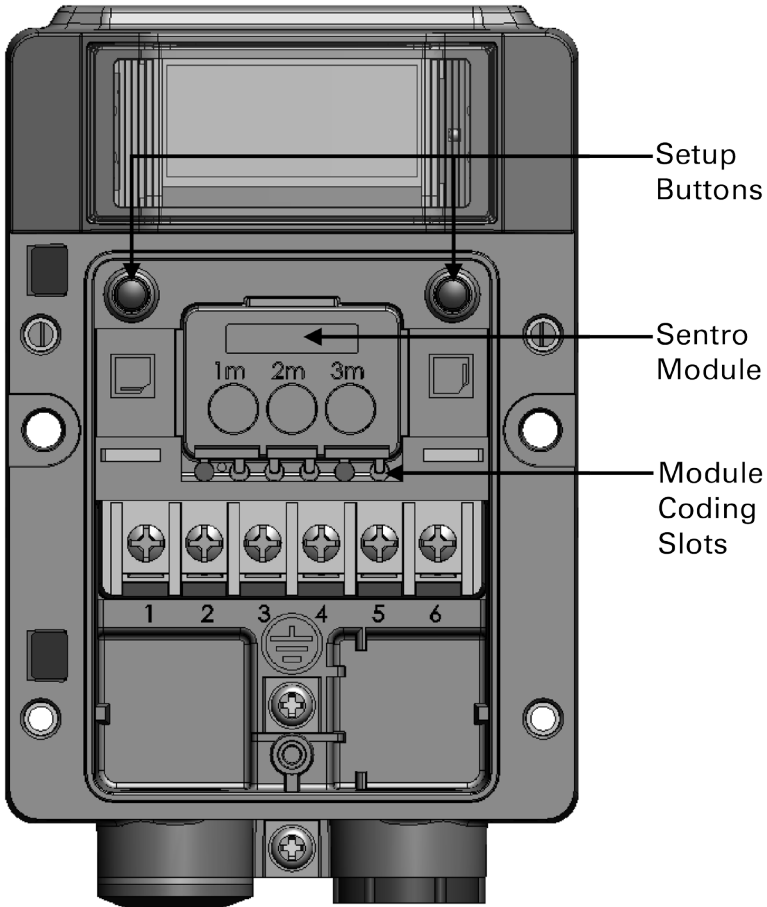

4.2 Software Menus

[Start-up Screen - Pg 28](#)

[Main Display - Pg 28](#)

[Main Menu - Pg 29](#)

[Sentro Setup - Pg 30](#)

[System Information - Pg 30](#)

[Display Setup - Pg 30](#)

[Set Backlight - Pg 31](#)

[Adjust Contrast - Pg 32](#)

[Exit - Pg 32](#)

[Alert Setup - Pg 32](#)

[Visual Alert - Pg 33](#)

[Confidence Alarm - Pg 33](#)

[Exit - Pg 34](#)

[Set Security Code - Pg 34](#)

[Exit - Pg 34](#)

[Output Setup - Pg 35](#)

[0.4 to 2V Analogue Output Signal - Pg 35](#)

[Output Information - Pg 36](#)

[Trim Output Zero - Pg 36](#)

[Trim Output Span - Pg 37](#)

[Reset Output - Pg 37](#)

[Exit - Pg 38](#)

[4 to 20 mA Analogue Output Signal - Pg 38](#)

[Output Information - Pg 38](#)

[Trim Output Zero - Pg 38](#)

[Trim Output Span - Pg 39](#)

[Reset Output - Pg 40](#)

[Exit - Pg 40](#)

[Dual Relay Contact Output Signal - Pg 40](#)

[Set Relay 1 Mode - Pg 40](#)

[Set Relay 2 Mode - Pg 40](#)

[Exit - Pg 41](#)

[RS485 Data Output Signal - Pg 42](#)

[Modbus Address - Pg 42](#)

[Baud Rate - Pg 43](#)

[TxOn Delay - Pg 43](#)

[TxOff Delay - Pg 43](#)

[Exit - Pg 44](#)

[Module Setup - Pg 44](#)

[Scaling - Pg 45](#)

[Sig. Figures - Pg 46](#)

[Lower Range - Pg 46](#)

[Upper Range - Pg 46](#)

[Units - Pg 47](#)

[Scale Factor - Pg 48](#)

[Exit - Pg 49](#)

[Setpoint 1 - Pg 49](#)

[Activation - Pg 50](#)

[Level - Pg 50](#)

[Exit - Pg 51](#)

[Setpoint 2 - Pg 49](#)

[Activation - Pg 50](#)

[Level - Pg 50](#)

[Exit - Pg 51](#)

[Configuration - Pg 51](#)

[Set Duty Text - Pg 52](#)

[Set Update - Pg 53](#)

[Exit - Pg 54](#)

[Exit - Pg 54](#)

[Exit - Pg 54](#)

4.3 Navigation



NEXT

SELECT/CHANGE

Checkpoint

To use the **Sentro Vortex** software and navigate between menus you must press the Setup Buttons:

Next is the Left button - **L**

Select/Change is the Right button - **R**.

The use of these buttons is abbreviated to **L** and **R** throughout this User Manual.

To access the **L (Next)** and **R (Select/Change)** buttons you need to remove the front cover. Use a cross head screwdriver to remove the four screws securing the front cover and move it out of the way.

Checkpoint

The **Sentro Vortex** is factory configured with the Security Code unset. If a **Security Code** has been subsequently set it will need to be successfully entered before the menus can be accessed.

4.4 Power-up

When the **Sentro Vortex** is powered-up the **Start-up Screen** will appear. The **Start-up Screen** displays basic information about the system including the software version, driver version and output type.



After five seconds the **Main Display** will appear. The **Main Display** displays the current airflow.

4.5 Main Menu

From the **Main Display** press and hold **L**, this will bring up the **Main Menu**.

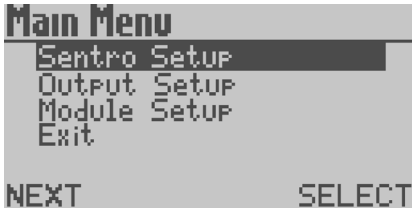

From the **Main Menu** the operating parameters of the **Sentro Vortex** may be set up according to preference. The available menus are as follows:

- **Sentro Setup**
- **Output Setup**
- **Module Setup**
- **Exit**

Checkpoint

You can safely remove the front cover of the **Sentro Vortex** for setup in a hazardous area, even with the power applied.

Checkpoint

The **Sentro Vortex** will automatically return to the **Main Display** if no keys are pressed within 30 seconds.

4.5.1 Sentro Setup

This enables you to view and carry-out setup of the **Sentro Vortex** characteristics.

From the **Main Menu** press **L**, navigate to **Sentro Setup** and press **R** to enter the **Sentro Setup Menu**.

The available menus are as follows:

- **System Information**
- **Display Setup**
- **Alert Setup**
- **Set Security Code**
- **Exit**

4.5.1.1 System Information

This displays basic information about the system including the main software version, system date, system time, driver versions and output formats.

From the **Sentro Setup Menu** press **L**, navigate to the **System Information** and press **R** to display the **System Information**.

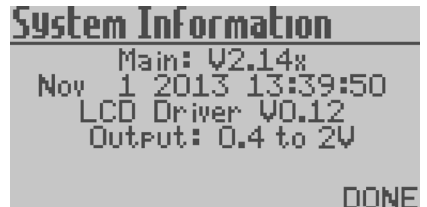
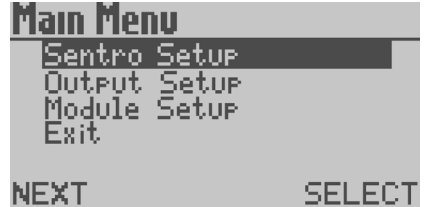



4.5.1.2 Display Setup Menu

This enables you to carry-out the setup of the **Display**.

From the **Sentro Setup Menu** press **L**, navigate to the **Display Setup** and press **R** to enter the **Display Setup Menu**.

The available menus are as follows:

- **Set Backlight**
- **Adjust Contrast**
- **Exit**

Set Backlight

The screen backlight illumination may be set to **On** or **Off**, to reduce power consumption.

From the **Display Setup Menu** press **L**, navigate to **Set Backlight** and press **R** to enter the **Set Backlight Menu**.

From the **Set Backlight Menu** press **R** to set the Backlight Illumination to **On** or **Off** as required.

Press **L** to move to **Save** or **Cancel** as required. Press **R** to confirm the selection and return to the **Display Setup Menu**.

Adjust Contrast



The contrast of the screen may be set for best visual appearance.

From the **Display Setup Menu** press **L**, navigate to **Adjust Contrast** and press **R** to enter the **Adjust Contrast Menu**.

Press **L** to navigate to **Increase** or **Decrease** as required. Press **R** to **Increase** or **Decrease** the contrast as required.

Press **L** and select **Save** or **Cancel** as required. Press **R** to confirm the selection and return to the **Display Setup Menu**.

Exit

From the **Display Setup Menu** press **L**, navigate to **Exit**, press **R** to confirm the selection and return to the **Sentro Setup Menu**.

4.5.1.3 Alert Setup Menu

This enables you to carry-out the setup of the **Alerts**.

From the **Sentro Setup Menu** press **L**, navigate to **Alert Setup** and press **R** to enter the **Alert Setup Menu**.

The available menus are as follows:

- **Visual Alert**
- **Confidence Alarm**
- **Exit**

Visual Alert



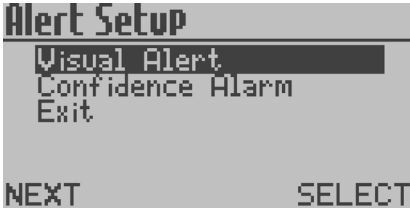

The integral **General** and **High** visual alarms can be set to **On** or **Off**.

From the **Alert Setup Menu** press **L**, navigate to **Visual Alarm** and press **R** to enter the **Visual Alarm Menu**.

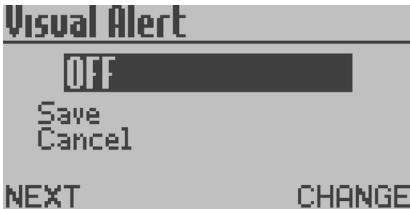

From the **Visual Alarm Menu** press **R** to set the **Visual Alarm** to **On** or **Off** as required.

Press **L** and navigate to **Save** or **Cancel** as required. Press **R** to confirm the selection and return to the **Alert Setup Menu**.



Confidence Alarm

The **Confidence Alarm** flash can be set to **On** or **Off**. For details of the **Confidence Alarm** refer to **Section 5**.

From the **Alert Setup Menu** press **L**, navigate to **Confidence Alarm** and press **R** to enter the **Confidence Alarm Menu**.

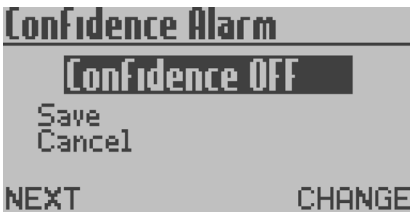

From the **Confidence Alarm Menu** press **R** to set the **Confidence Alert** to **On** or **Off** as required.

Press **L** to move to **Save** or **Cancel** as required.

Press **R** to confirm the selection and return to the **Alert Setup Menu**.

Exit

From the **Alert Setup Menu** press **L**, navigate to **Exit** and press **R** to confirm the selection and return to the **Sentro Setup Menu**.

4.5.1.4 Set Security Code

This enables you to enter a **Security Code** and prevent unauthorised access to the **Main Menu**.

From the **Sentro Setup Menu** press **L**, navigate to **Set Security Code** and press **R** to enter the **Set Security Code** menu.

From **Set Security Code** press **R** to increment the first digit. Press **L** to confirm the selection and move to the next digit.

Repeat for all four digits. Press **L** and navigate to **Save** or **Cancel** as required and Press **R** to confirm the selection.

4.5.1.5 Exit

From the **Sentro Setup Menu** press **L**, navigate to **Exit**, press **R** to confirm the selection and return to the **Main Menu**.

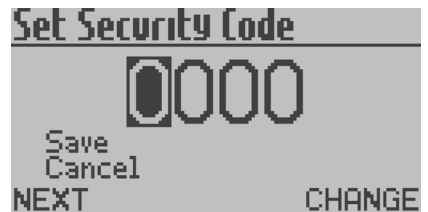
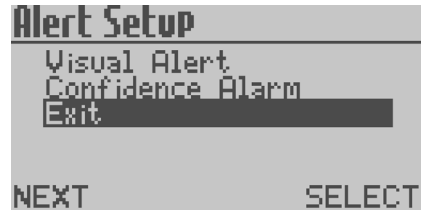

4.5.2 Output Setup

This enables you to view information on and setup characteristics of the **Sentro Vortex** output signal.

Checkpoint

The output signal type of the **Sentro Vortex** is configured during manufacture. The output signal will be one of four types:

- 0.4 to 2 V analogue output signal
- 4 to 20 mA analogue output signal
- Dual relay output signal
- RS485 digital output signal

Each of the four signal types has a unique set of menus that enable you to view and configure characteristics of the output signal. All four sets of menus are described in the following sections.

From the **Main Menu** press **L**, navigate to **Output Setup** and press **R** to enter the **Output Setup Menu**.

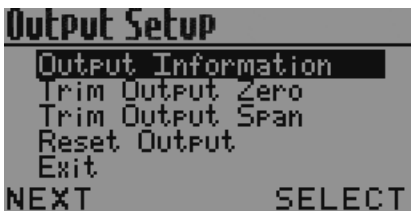

4.5.2.1 0.4 to 2V Analogue Output Signal

The available menus are as follows:

- **Output Information**
- **Trim Output Zero**
- **Trim Output Span**
- **Reset Output**
- **Exit**

Output Information

This displays the factory set output signal type for the **Sentro Vortex**.

From the **Output Setup Menu** press **L**, navigate to **Output Information** and press **R** to display the **Output Information**.

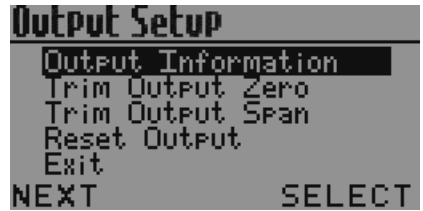

Trim Output Zero

The level of the transmitted output signal, when the **Sentro Vortex** is measuring a zero gas flow can be trimmed or offset.

From the **Output Setup Menu** press **L**, navigate to **Trim Output Zero** and press **R** to enter the **Trim Output Zero Menu**.

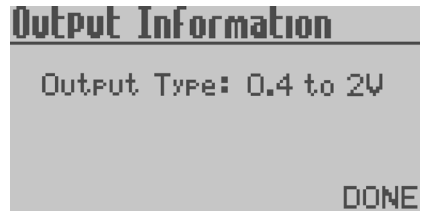

Press **L** to navigate to **Increase** or **Decrease** as required. Press **R** to **Increase** or **Decrease** the **Output Zero** as required.

Press **L** and select **Save** or **Cancel** as required. Press **R** to confirm the selection and return to the **Output Setup Menu**.

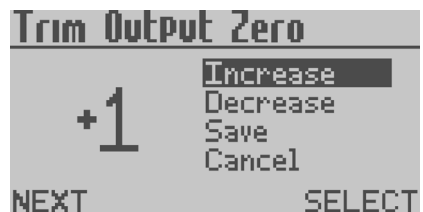
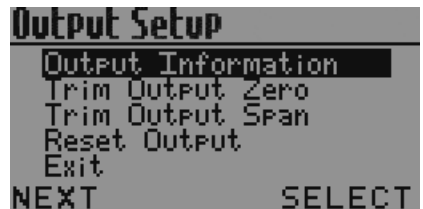

Trim Output Span

The level of the transmitted output signal, when the **Sentro Vortex** is measuring a given gas flow can be trimmed or offset.

From the **Output Setup Menu** press **L**, navigate to **Trim Output Span** and press **R** to enter the **Trim Output Span Menu**.

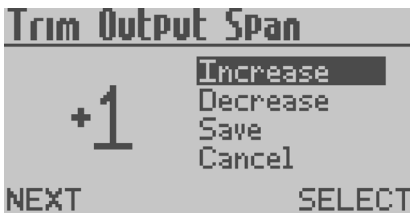

Press **L** to navigate to **Increase** or **Decrease** as required. Press **R** to **Increase** or **Decrease** the **Output Span** as required.

Press **L** and select **Save** or **Cancel** as required. Press **R** to confirm the selection and return to the **Output Setup Menu**.

Reset Output

This enables you to reset the **Zero** and **Span** output signal levels back to the default factory settings.

From the **Output Setup Menu** press **L**, navigate to **Reset Output** and press **R** to enter the **Reset Output** menu.

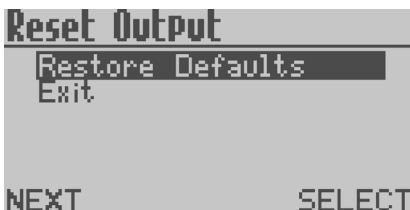
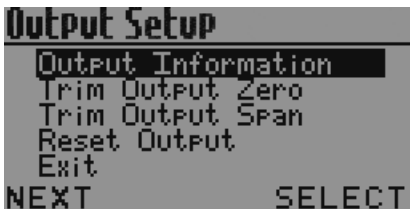

Press **L** to navigate to **Restore Defaults** and press **R** to confirm the selection.

Exit

From the **Output Setup Menu** press **L**, navigate to **Exit**, press **R** to confirm the selection and return to the **Main Menu**.

4.5.2.2 4 to 20 mA Analogue Output Signal

The available menus are as follows:

- **Output Information**
- **Trim Output Zero**
- **Trim Output Span**
- **Reset Output**
- **Exit**

Output Information

This displays the factory set output signal type for the **Sentro Vortex**.

From the **Output Setup Menu** press **L**, navigate to **Output Information** and press **R** to display the **Output Information**.

Trim Output Zero

The level of the transmitted output signal, when the **Sentro Vortex** is measuring a zero gas flow can be trimmed or offset.

From the **Output Setup Menu** press **L**, navigate to **Trim Output Zero** and press **R** to

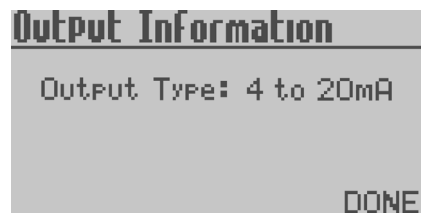
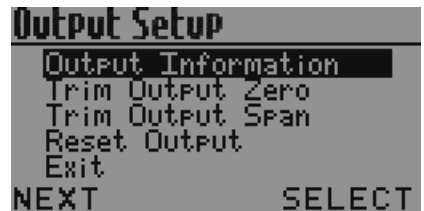
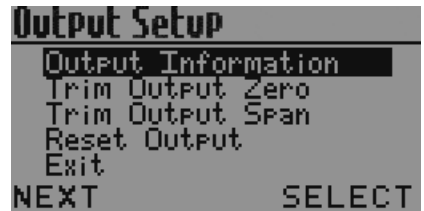

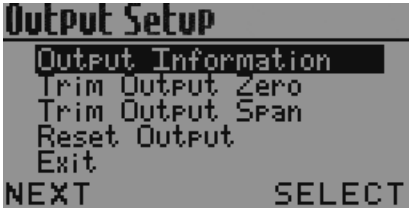

enter the **Trim Output Zero Menu**.

Press **L** to navigate to **Increase** or **Decrease** as required. Press **R** to **Increase** or **Decrease** the **Output Zero** as required.

Press **L** and select **Save** or **Cancel** as required. Press **R** to confirm the selection and return to the **Output Setup Menu**.

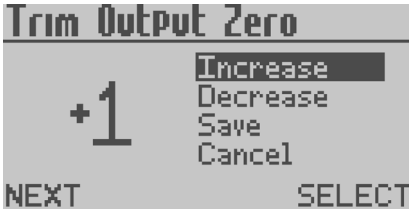

Trim Output Span

The level of the transmitted output signal, when the **Sentro Vortex** is measuring a given gas flow can be trimmed or offset.

From the **Output Setup Menu** press **L**, navigate to **Trim Output Span** and press **R** to enter the **Trim Output Span Menu**.

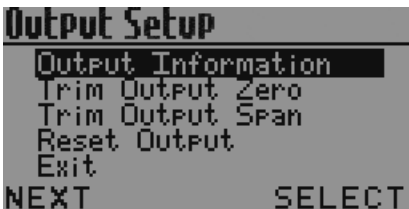

Press **L** to navigate to **Increase** or **Decrease** as required. Press **R** to **Increase** or **Decrease** the **Output Span** as required.

Press **L** and select **Save** or **Cancel** as required. Press **R** to confirm the selection and return to the **Output Setup Menu**.

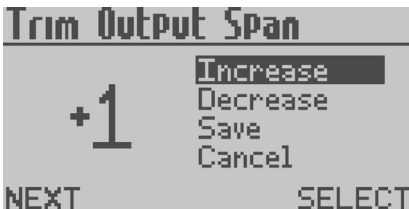

Reset Output

This enables you to reset the **Zero** and

Span output signal levels back to the default factory settings.

From the **Output Setup Menu** press **L**, navigate to **Reset Output** and press **R** to enter the **Reset Output** menu.

Press **L** to navigate to **Restore Defaults** and press **R** to confirm the selection.

Exit

From the **Output Setup Menu** press **L**, navigate to **Exit**, press **R** to confirm the selection and return to the **Main Menu**.

4.5.2.3 Dual Relay Contact Output Signal

The available menus are as follows:

- **Set Relay 1 Mode**
- **Set Relay 2 Mode**
- **Exit**

Set Relay 1 Mode and Set Relay 2 Mode

This enables you to setup the operating function of each relay. Each Relay can be independently setup.

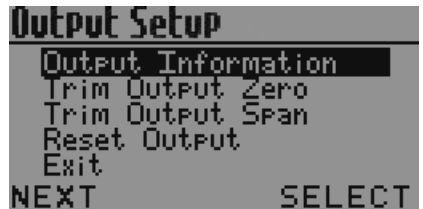
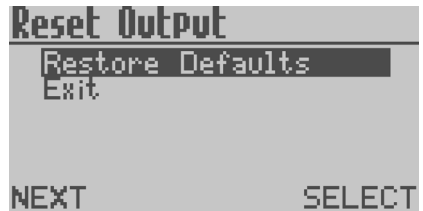
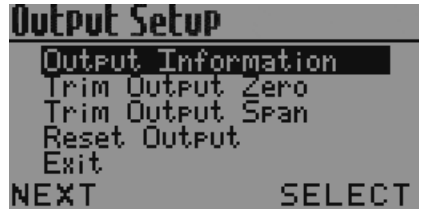

Checkpoint

Set Relay 1 Mode and **Set Relay 2 Mode** are configured in exactly the same way as each other.

Checkpoint

A relay can be configured to **Latch** or **Automatically Reset** according to preference.



From the **Output Setup Menu** press **L**, navigate to **Set Relay 1 Mode** or **Set Relay 2 Mode** and press **R** to enter **Set Relay 1 Mode** or **Set Relay 2 Mode**.

Press **R** to change from **Latch** and **Auto**. Press **L** and select **Save** or **Cancel** as required. Press **R** to confirm the selection and return to the **Output Setup Menu**.

Checkpoint

A relay configured to **Latch** cannot be reset until the initiating signal has receded.

Exit

From **Set Relay 1 Mode** or **Set Relay 2 Mode** press **L**, navigate to **Exit** and press **R** to confirm the selection and return to the **Output Setup Menu**.

4.5.2.4 RS485 Data Output Signal

The available menus are as follows:

- **Modbus Address**
- **Baud Rate**
- **TxOn Delay**
- **TxOff Delay**
- **Exit**

Modbus Address

The **Modbus Address** can be set between **1** and **255** as required.

From the **Output Setup Menu** press **L**, navigate to **Modbus Address** and press **R** to enter the **Modbus Address Menu**.

Press **L** to navigate to **Increase** or **Decrease** as required. Press **R** to **Increase** or **Decrease** the **Modbus Address** as required.

Press **L** and navigate to select **Save** or **Cancel** as required. Press **R** to confirm the selection and return to the **Output Setup Menu**.

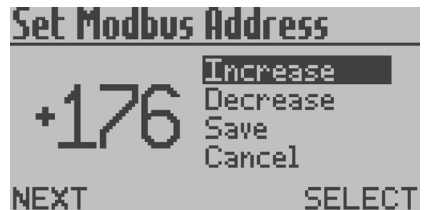
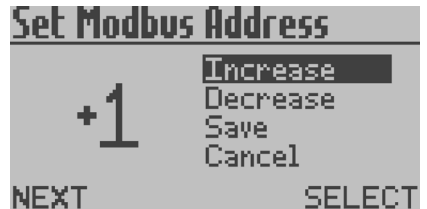

```
Modbus Setup
-----
Modbus Address
Baud Rate
TxOn Delay
TxOff Delay
Exit
NEXT                SELECT
```

Baud Rate

The Baud Rate can be set to 300/600/1200/2400/4800/9600/14400/19200/28800/38400/57600/115200 as required.

From the **Output Setup Menu** press **L**, navigate to **Baud Rate** and press **R** to enter the **Set Baud Rate Menu**.

Press **R** to navigate to the required **Baud Rate**, press **L** and select **Save** or **Cancel** as required. Press **R** to confirm the selection and return to the **Output Setup Menu**.

```
Set Baud Rate
-----
115200
Save
Cancel
NEXT                CHANGE
```

TxOn Delay and TxOff Delay

Checkpoint

TxOn Delay and **TxOff Delay** are configured in exactly the same way as each other.

The **TxOn Delay** and **TxOff Delay** can be set between 0 and 99 ms.

From the **Output Setup Menu** press **L**, navigate to **TxOn Delay** or **TxOff Delay** as required and Press **R** to enter the **TxOn Delay** or **TxOff Delay Menu** as required.

```
Modbus Setup
-----
Modbus Address
Baud Rate
TxOn Delay
TxOff Delay
Exit
NEXT                SELECT
```

Press **L** to navigate to **Increase** or **Decrease** as required. Press **R** to **Increase** or **Decrease** as required. Press **L** and select **Save** or **Cancel** as required. Press **R** to confirm the selection and return to the **Output Setup Menu**.

Exit

From the **Output Setup Menu** press **L**, navigate to **Exit**, press **R** to confirm the selection and return to the **Main Menu**.

4.5.3 Module Setup

This enables you to setup the functional values of the **Sentro Module** fitted to **Sentro Vortex**.

From the **Main Menu** press **L**, navigate to **Module Setup** and press **R** to enter the **Module Setup Menu**.

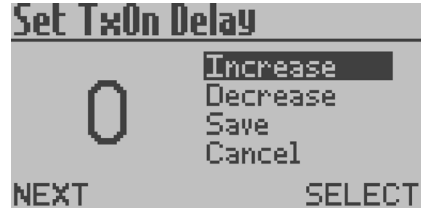

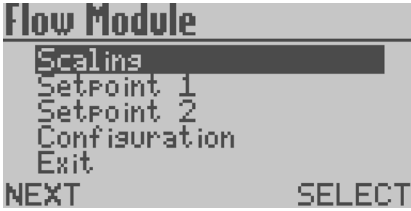

The available menus are as follows:

- **Scaling**
- **Setpoint 1**
- **Setpoint 2**
- **Configuration**
- **Exit**

4.5.3.1 Scaling

This enables you to carry-out a setup of the **Scaling** functions.

From the **Module Setup Menu** press **L**, navigate to **Scaling** and press **R** to enter the **Scaling Setup Menu**.

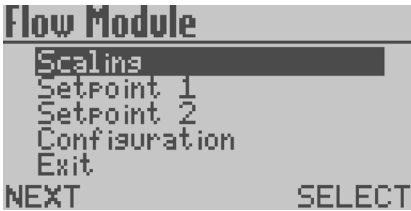

The available menus are as follows:

- **Sig. Figures**
- **Lower Range**
- **Upper Range**
- **Units**
- **Scale Factor**
- **Exit**

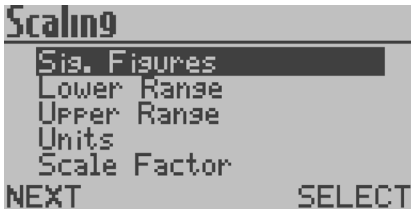

Significant Figures

The position of the decimal point can be shifted along the displayed number to the best **Significant Figures** to suit the particular sensor signal being monitored and its optimum measuring range. This can be used to eliminate digit flicker and redundant decimal places.

From the **Scaling Setup Menu** press **L**, navigate to **Sig. Figures** and press **R** to enter the **Significant Figures Menu**.

Press **R** to move the decimal point to the preferred position to give the number of decimal places required.

Press **L** and select **Save** or **Cancel** as required. Press **R** to confirm the selection and return to the **Scaling Setup Menu**.

Lower Range and Upper Range

Set the desired **Lower Range** and **Upper Range** of the displayed reading for a given magnitude of input signal. This can be any numeric value and the polarity can be any negative value through to any positive value.

Checkpoint

Enter the preferred **Significant Figures** before setting the Lower Range and **Upper Range** values.

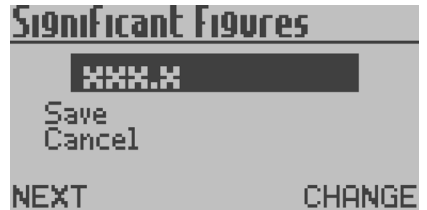
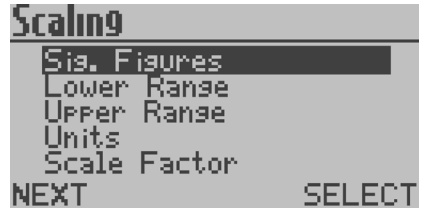

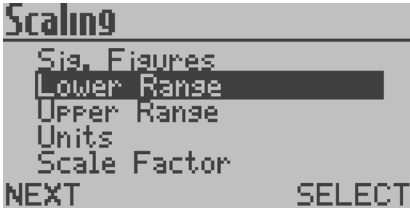

From the **Scaling Setup Menu** press **L**, navigate to **Lower Range** or **Upper Range** as required and press **R** to enter the **Lower Range** or **Upper Range Menu** as required.

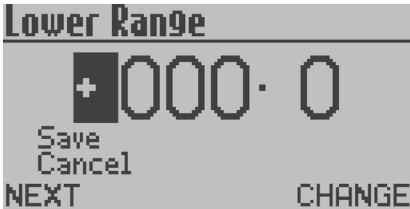

Press **R** to change the minus to a plus. Press **L** to move to the first digit, press **R** to increment the digit and press **L** to move to the next digit.

Press **L** and select **Save** or **Cancel** as required. Press **R** to confirm the selection and return to the **Scaling Setup Menu**.

Units

The displayed **Units** of gas flow can be changed according to preference. Two types of **Units** can be displayed:

- **Flow Velocity Values** - independent of the cross-sectional area of the flow path
- **Volumetric Flow Values** - relative to the cross-sectional areas of the flow path

The default **Units** displayed are m/s (metre/second). The **Units** that can be displayed are as follows:

Flow Velocity Values

- m/s - metres per second
- ft/s - feet per second

Volumetric Flow Values

- m³/s - cubic metres per second
- m³/h - cubic metres per hour
- ft³/s - cubic feet per second
- ft³/h - cubic feet per hour

From the **Scaling Setup Menu** press **L**, navigate to **Units** and press **R** to enter the **Units Menu**.

Press **R** to change the displayed **Units** to the preferred **Units** to be displayed.

Press **L** and select **Save** or **Cancel** as required. Press **R** to confirm the selection and return to the **Scaling Setup Menu**.

Scale Factor

If one of the four **Volumetric Flow Value** units is selected, it will be necessary to enter a multiplication factor relating to the cross-sectional area of the flow path.

Checkpoint

The scale Factor is user rangeable between 1.0000 and 9.9999.

From the **Scaling Setup Menu** press **L**, navigate to **Scale Factor** and press **R** to enter the **Scale Factor Menu**.

Press **R** to increment the first digit, press **L** to move to the next digit, press **R** to increment the digit and repeat for all digits as required.

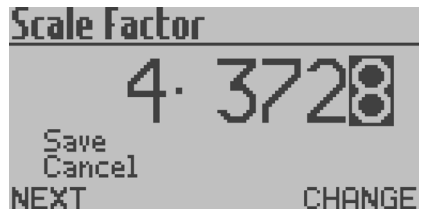
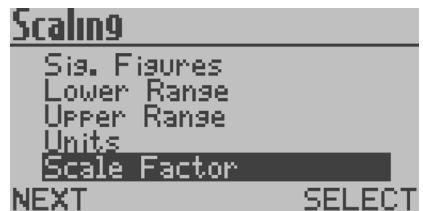
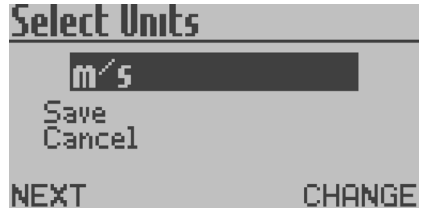
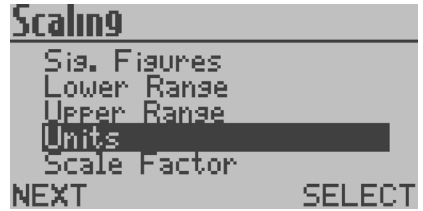

Press **L** and select **Save** or **Cancel** as required. Press **R** to confirm the selection and return to the **Scale Factor Setup Menu**.

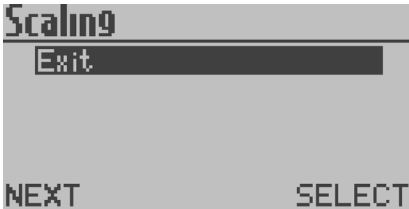

Exit

From the **Scaling Setup Menu** press **L**, navigate to **Exit** and press **R** to **Exit** the **Scaling Setup Menu** and return to the **Module Setup Menu**.

4.5.3.2 Setpoint 1 and Setpoint 2

This enables you to carry-out a setup of **Setpoint 1** and **Setpoint 2**.

Checkpoint

Setpoint 1 and **Setpoint 2** are configured in exactly the same way.

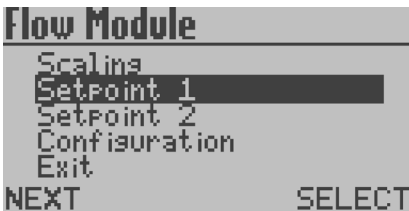

From the **Module Setup Menu** press **L**, navigate to **Setpoint 1** or **Setpoint 2** and press **R** to enter the **Setpoint 1** or **Setpoint 2 Setup Menu**.



The available menus are as follows:

- **Activation**
- **Level**
- **Exit**

Activation

The **Activation** mode of **Setpoint 1** and **Setpoint 2** can be configured to **Over** or **Under** as required.

From the **Setpoint 1** or **Setpoint 2 Setup Menu** press **L**, navigate to **Activation** and press **R**.

From the **Activation Menu** press **R** to set **Activation** to **Over** or **Under** as required.

Press **L** and navigate to **Save** or **Cancel** as required. Press **R** to confirm the selection and return to the **Setpoint 1** or **Setpoint 2 Setup Menu**.

Level

The **Level** at which **Setpoint 1** and **Setpoint 2** are activated can be configured.

From the **Setpoint 1** or **Setpoint 2 Setup Menu** press **L**, navigate to **Level** and press **R**.

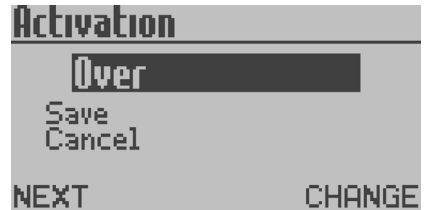

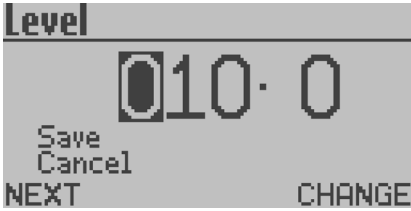

Press **R** to increment the digits as required. Press **L** to move to the next digit. Repeat for all digits and press **L**.

Press **L** and select **Save** or **Cancel** as required. Press **R** to confirm the selection and return to the **Setpoint 1** or **Setpoint 2 Setup Menu**.

Exit

From the **Setpoint 1** or **Setpoint 2 Setup Menu** press **L**, navigate to **Exit**, press **R** to confirm the selection and return to the **Module Setup Menu**.



4.5.3.3 Configuration

This enables you to setup the **Configuration** of the sensing module.

From the **Module Setup Menu** press **L**, navigate to **Configuration** and press **R** to enter the **Configuration Setup Menu**.

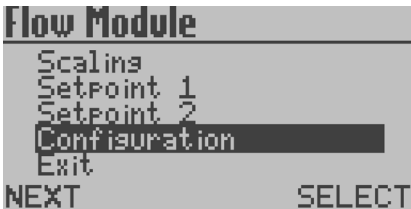

The available menus are as follows:

- **Set Duty Text**
- **Set Update**
- **Exit**

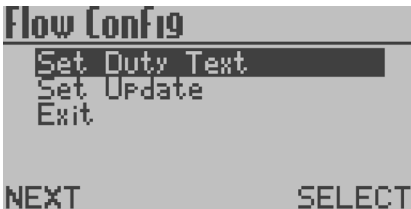

Set Duty Text

The **Duty Text** can be set according to preference, by default it reads **Airflow**.

From the **Configuration Setup Menu** press **L**, navigate to **Set Duty Text** and press **R** to enter the **Set Duty Text Menu**.

From the **Set Duty Text Menu** press **R** to increment a character as required and press **L** to move to the next character.

Checkpoint

The characters are in the sequence **A** to **Z**, **0** to **9** and a **Blank Space**.

Checkpoint

If you wish to clear all text press **L**, navigate to **Clear Text** and press **R** to clear all **Duty Text** as required.

Checkpoint

The maximum number of characters that can be entered in the **Duty Text** field is 16.

Press **L** and select **Save** or **Cancel** as required. Press **R** to confirm the selection and return to the **Configuration Setup Menu**.

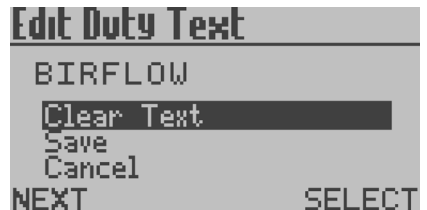
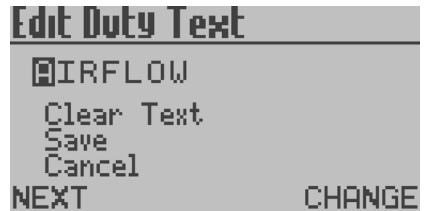
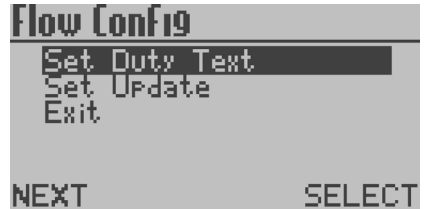

Set Update

The value of the analogue input signal is averaged and up-dated at periodic intervals. You can configure the up-date period in the **Set Update Menu**.

Checkpoint

A low **Set Update** setting will give rapid reaction to the input signal and a higher setting may be entered where damping of a fluctuating input is necessary, or simply as a means of applying a delay to the input. This is particularly useful in electrically noisy environments.

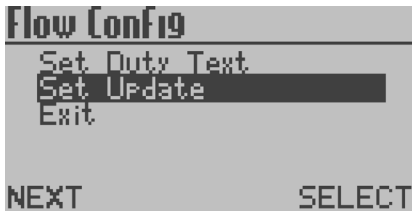

From the **Configuration Setup Menu** press **L**, navigate to **Set Update** and press **R** to enter the **Set Update Menu**.

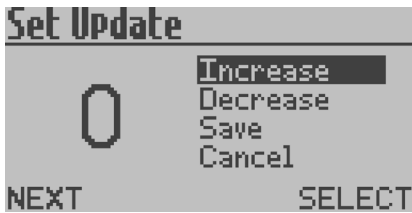

Press **L** to navigate to **Increase** or **Decrease** as required. The field is configurable between 0 and 99 seconds.

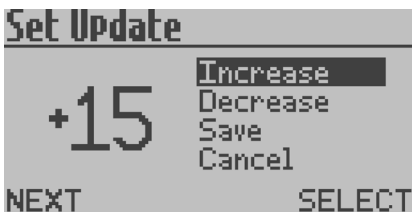

Press **R** to **Increase** or **Decrease** as required. Press **L** and select **Save** or **Cancel** as required. Press **R** to confirm the selection and return to the **Configuration Setup Menu**.

Exit

From the **Configuration Setup Menu** press **L** and navigate to **Exit**. Press **R** to confirm the selection and return to the **Module Setup Menu**.

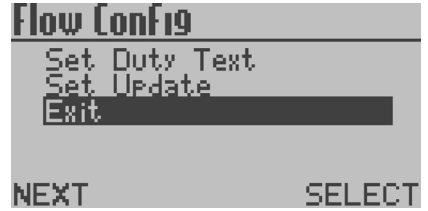

4.5.3.4 Exit

From the **Module Setup Menu** press **L**, navigate to **Exit** and press **R** to confirm the selection and return to the **Main Menu**.

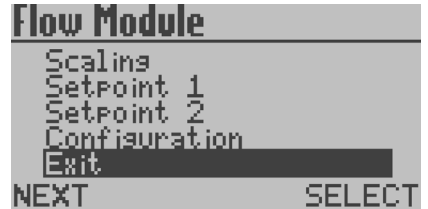

4.5.4 Exit

From the **Main Menu** press **L**, navigate to **Exit** and press **R** to confirm the selection and return to the **Main Display**.



4.6 Support

If you need technical support to operate this product, or would like details of our after sales technical support packages, please contact your local Trolex service agent or service@trolex.com.



5. Operation

In normal operation the **Sentro Vortex** will display the gas flow rate on the LCD screen in the preferred **Units** of measurement, this is the **Main Display**. If the **Confidence Alert** has been enabled it will flash every 15 seconds.

5.1 Dual Relay Contact Output Signal

On the Dual Relay Contact Output version of **Sentro Vortex** the functional mode and status of the relays can be displayed at any time. Press **L** and the relay state will be displayed.

5.1.1 To Reset a Latched Relay

If a relay is latched during operation, reset it as follows. From the **Main Display** press **R** to open the **Unlatch Relays** menu.

The available menus are as follows:

- **Unlatch Relay 1**
- **Unlatch Relay 2**
- **Go to Main Menu**
- **Exit**

5.1.1.1 Unlatch Relay 1 and Unlatch Relay 2

Checkpoint

Relay 1 and **Relay 2** are unlatched in exactly the same way.

From the **Unlatch Relays Menu** press **L**, navigate to **Unlatch Relay 1** or **Unlatch Relay 2** and press **R**.

Press **L** to navigate to **Unlatch Relay 1** or **Unlatch Relay 2** as required and press **R** unlatch the relay.

Press **L** to navigate to **Unlatch Relay 1** or **Unlatch Relay 2** and press **R** to confirm the selection.

5.1.1.2 Go to Main Menu

From the **Unlatch Relays Menu** press **L**, navigate to **Go to Main Menu**, press **R** and return to the **Main Menu**.

5.1.1.3 Exit

From the **Unlatch Relays Menu** press **L**, navigate to **Exit**, press **R** and return to the **Main Display**.

Checkpoint

A relay configured to **Latch** cannot be reset until the initiating signal has receded.



6. Diagnostics and Maintenance

6.1 Diagnostic Messages

Sensor Over-range

If the **Sentro Vortex** goes over-range then the following message will be seen on the LCD screen.

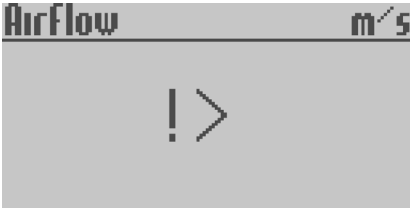

Loss of Signal From the Sensor

If there is a loss of signal from the sensing module to the **Sentro Vortex** an error message will be shown.

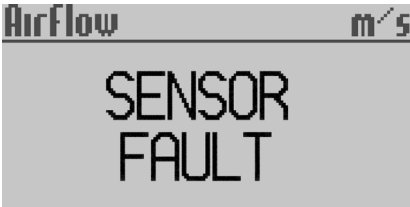

Module Not Fitted

If the sensing module has been removed from the **Sentro Vortex** and is out for more than 10 seconds, an error message will be shown.

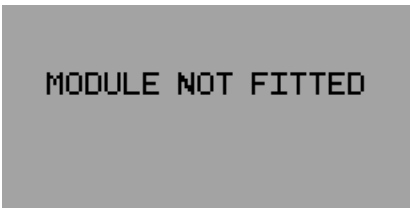

6.2 Maintenance

6.2.1 Introduction

To keep your **Sentro Vortex** in the best possible condition and minimise downtime, Trolex strongly recommends that you carry out regular planned preventative maintenance and keep records of the maintenance carried out. The planned preventative maintenance for **Sentro Vortex** consists of a number of tasks carried out at regular intervals on a cumulative basis, ie. at 12 months do the 1 month task, the 3 month task, the 6 month task AND the 12 month task. These tasks are listed in the maintenance schedule below:

Equipment Name	Task Type	Task Number	Interval
Sentro Vortex	Check	6.2.2	1 month
Sentro Vortex Sensing Probe	Clean	6.2.3	3 months
Sentro Vortex Output Signal	Check	6.2.4	6 months
Sentro Vortex Sensing Probe	Function Test	6.2.5	12 months



6.2.2 Sentro Vortex - Check

1. Check the exterior of the **Sentro Vortex** for cracks, penetration, water ingress and other signs of damage.
2. Check that the front cover is free from damage and is securely fitted.
3. Check the LCD screen is clear and free from damage.
4. If any part of the **Sentro Vortex** shows any signs of damage, deformation or missing parts, contact your local Trolex service agent or **service@trolex.com** for advice on repair or replacement.
5. After the completion of all maintenance, update the maintenance records.

6.2.3 Sentro Vortex Sensing Probe - Clean

1. Remove the sensor and assess its condition.
2. Clean the sensing head with a soft brush or cloth if necessary.

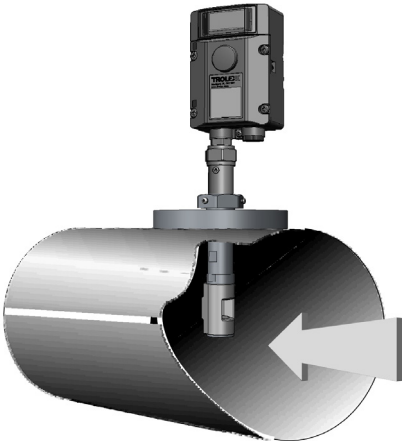

Checkpoint

Do not use sharp tools as this may cause damage to the ultrasound transducers and the transverse strut.

3. After the completion of all maintenance, update the maintenance records.

6.2.4 Sentro Vortex Output Signal - Check

1. Using a test meter check that the value of the output signal agrees with the value of the display reading.
2. After the completion of all maintenance, update the maintenance records.

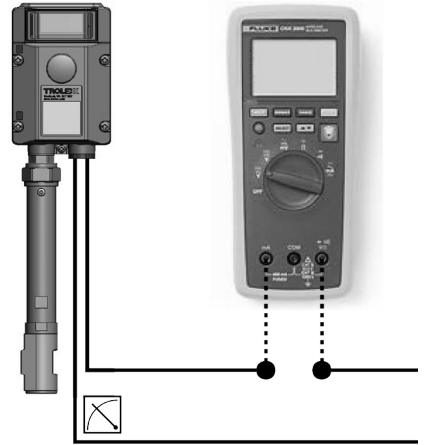

6.2.5 Sentro Vortex Sensing Probe - Function Test

1. Under normal circumstances, the calibration of the sensing probe will not change significantly.
2. Check the accuracy by comparing the display reading with a reference value of flow velocity.

OR

2. Alternatively the **Sentro Vortex** can be removed and returned to your local Trolex service agent, for checking and calibration across the full operating spectrum. Contact service@trolex.com for further information.
3. After the completion of all maintenance, update the maintenance records.

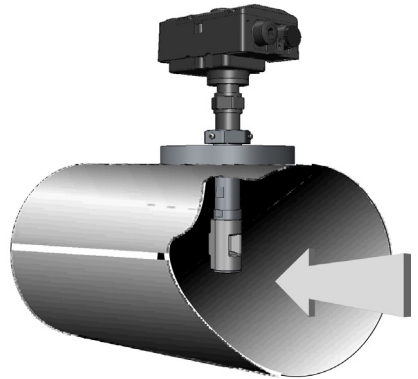

6.3 Disposal

Part of the ethos of Trolex is sustainable design. **Sentro Vortex** contains materials that can be recovered, recycled and reused. At the end of its useful life ensure that the **Sentro Vortex** is recycled in accordance with local laws and bylaws for the geographic area where it is located. The end of its useful life is to be determined by the owner/operator of the equipment and not Trolex. Ensure that the **Sentro Vortex** is recycled by licenced waste contractors with the appropriate licences for handling metal, plastic and electronic waste in the geographic area where the **Sentro Vortex** is located.

Checkpoint

Consult your local Trolex service agent or the Trolex Product Support Department if you require assistance with disposal:

service@trolex.com

6.4 Maintenance Records

Implement a planned preventative maintenance process and keep good maintenance records.

Consult your local Trolex service agent or the Trolex Product Support Department: **service@trolex.com** for help in implementing a planned preventative maintenance process.

The 'Maintenance Log' gives an example of a typical maintenance record system.

6.5 Maintenance and Calibration Log

Order Reference: TX5951	
Serial Number:	Date Purchased:
Location:	Flow Rate:

Date	Scheduled Check	Fault	Recalibrate	Return to Trolex	Comments

Disclaimers

The information provided in this document contains general descriptions and technical characteristics of the performance of the product. It is not intended as a substitute for and is not to be used for determining suitability or reliability of this product for specific user applications. It is the duty of any user or installer to perform the appropriate and complete risk analysis, evaluation and testing of the products with respect to the relevant specific application or use. Trolex shall not be responsible or liable for misuse of the information contained herein. If you have any suggestions for improvements or amendments, or find errors in this publication, please notify us at marketing@trolex.com.

No part of this document may be reproduced in any form or by any means, electronic or mechanical, including photocopying, without express written permission of Trolex.

All pertinent state, regional, and local safety regulations must be observed when installing and using this product. For reasons of safety and to help ensure compliance with documented system data, only Trolex or its affiliates should perform repairs to components.

When devices are used for applications with technical safety requirements, the relevant instructions must be followed.

Trademarks

© 2014 Trolex® Limited.

Trolex is a registered trademark of Trolex Limited. The use of all trademarks in this document is acknowledged.

Document History

Issue 01 30 September 2014 Original publication of this document - 6th draft

Contact Details

Trolex Ltd, Newby Road, Hazel Grove, Stockport, Cheshire, SK7 5DY, UK
+44 (0) 161 483 1435 sales@trolex.com

TROLEX«

Trolex Ltd. Newby Road, Hazel Grove, Stockport, Cheshire SK7 5DY, UK
t: +44 (0)161 483 1435 **e:** sales@trolex.com www.trolex.com