

TROLEX



AIR XKS

USER MANUAL

1	General description	4
1.1	Main features.....	5
1.2	Limits of use.....	5
2	Product safety	6
3	Danger from process	7
4	Safety procedures	8
4.1	Laser safety precautions.....	8
5	System components	10
5.1	TX8100 Air XS Silica Monitor.....	11
5.2	Particulate flow path.....	12
5.3	Peripherals and accessories.....	13
6	Certification	14
6.1	Compliance.....	14
7	Technical information	15
7.1	Product specification.....	15
7.2	Product dimensions.....	17
8	Hardware installation	18
8.1	Safety precautions.....	18
8.2	Mounting details.....	19
8.3	Electrical connections.....	20
8.4	I/O terminals.....	21
8.5	Power connections.....	21
9	Commissioning	22
9.1	First power on.....	22
9.2	System shutdown.....	22
9.3	BreatheXS software.....	23

10	Controls and indicators	24
10.1	Navigation.....	24
11	General operation	25
11.1	User interface display.....	25
11.2	Particulate display information.....	26
12	Instrument configuration	28
12.1	Default settings.....	28
12.2	On-site configuration.....	28
12.3	Custom alarms.....	28
12.4	External audio-visual (AV) alarm set-up.....	29
13	Updating firmware	31
14	Maintenance	32
14.1	Visual checks.....	32
14.2	Cleaning labels.....	32
14.3	Particulate entry/exit apertures.....	32
14.4	Filter replacement.....	32
14.5	Warranty.....	32
15	Troubleshooting	33
15.1	High temperature operating.....	33
15.2	Fault codes.....	33
16	Glossary and definitions	34
17	Disposal	35
18	Get in touch	36
18.1	Feedback.....	37
	Disclaimer	38
	Trademark	38

1. GENERAL DESCRIPTION

The Trolex Air XS Silica Monitor is designed to provide detailed, accurate and real-time data on airborne RCS content based on the chosen installation environment. Using innovative optical refraction technology (ORT), the Air XS combines a consistent particle flow rate with advanced sensing technology to provide information on airborne dust mixtures.

As the Air XS processes and analyses particulate data, an adaptive algorithm is used to calculate and identify the average level of RCS from the overall particle count. Measurement information can be viewed via the instrument display or as historical readings using the accompanying Trolex Breathe application software.



TX8100 Air XS Silica Monitor

1.1 Main features

- Real-time, continuous measurement of atmospheric RCS concentration
- Real-time, continuous measurement of dust particle count
- High-reliability and low-maintenance
- On-device display readout
- High visibility alarm warning indicators
- 'Plug and play' installation

1.2 Limits of use

The Air XS has been designed for use in environments where hazardous RCS is present. Resulting RCS detection can be influenced by total particle orientation, shape, size, and overall dust loading. The Air XS sensor may see some cross-responsivity from poly-crystalline particles present in the local environment.

To ensure the optimum performance and safe operation, the Air XS must be operated according to the limits detailed in the technical data section of this user manual. Operation outside of these limits may result in damage to the equipment or failure to achieve the performance specification.

Continual operation of the Air XS at extremes of the specified temperature limits may reduce the operating lifetime of the product.

Troxex will not be liable for any injury or damage caused by incorrect installation, setup, operation, or maintenance resulting from a failure to follow the procedures and safety instructions provided in this user manual.

The following symbols are used in this manual or on the instrument to indicate procedures that if not followed correctly, may result in personal injury or damage to equipment.



WARNING!

Alerts the user to a potentially hazardous procedure or practice which if not followed correctly can result in serious personal injury or injury of others.



CAUTION!

Alerts the user to a procedure or practice which, if not followed correctly can result in damage to the system or ancillary equipment.

In addition, the following symbols are used on the instrument



WARNING! – ELECTRIC SHOCK RISK



WARNING! – LASER RADIATION

The use of controls, adjustments, or procedures other than those specified in this user manual may result in exposure to hazardous optical radiation.

3. DANGER FROM PROCESS

It is possible that the Air XS could be installed in environments that contain process particulates which can be hazardous to health.

Unless process conditions are known to be entirely safe, suitable precautions such as the use of breathing apparatus or environmental purging/detoxifying should be employed before entry is made into the installation or maintenance environment.

Note: This product variant is not designed for use within Explosion Group or Zoned hazardous areas.

Always observe the safety precautions detailed in this user manual. Personnel installing, operating, or maintaining the equipment are responsible for their personal safety and correct handling of the equipment in accordance with all safety instructions detailed.

Follow all warnings and instructions marked on the instrument. Warning labels are situated on the instrument, indicating a hazard at or near the location of the warning label.

Retain these instructions in a safe and known place for future use.

The Air XS has been designed to be as simple to install and commission as possible. Nevertheless, installation in working environments can be challenging and correct set up is critical to the function of the instrument. It is important that you carefully read the entire User Manual before using and installing the Air XS for the first time and keep it in a safe place for future reference.

Peripheral components such as the power supply and communications module/peripheral or interface must be installed according to the manufacturer's instructions and the installation location's prevailing statutory regulations.

The installation of the instrument must only be carried out by competent personnel. Each installation needs to be considered with reference to the local safety regulations and authorities.

Observe the national safety regulations issued, for example, by the employers' liability insurance association, social security institutions, occupational safety and health or other safety authorities.

4.1 Laser safety precautions

The Air XS is rated via the *Class 1* 'Laser Safety Guideline' under all conditions of normal use.

Class 1 laser products may contain laser systems of a higher class but there are adequate engineering control measures to ensure that access to the beam is not permitted during normal use.



WARNING – *Class 3B* laser radiation: **do not** open the laser housing when the laser is powered on as it may result in eye damage from directly viewing the laser beam.

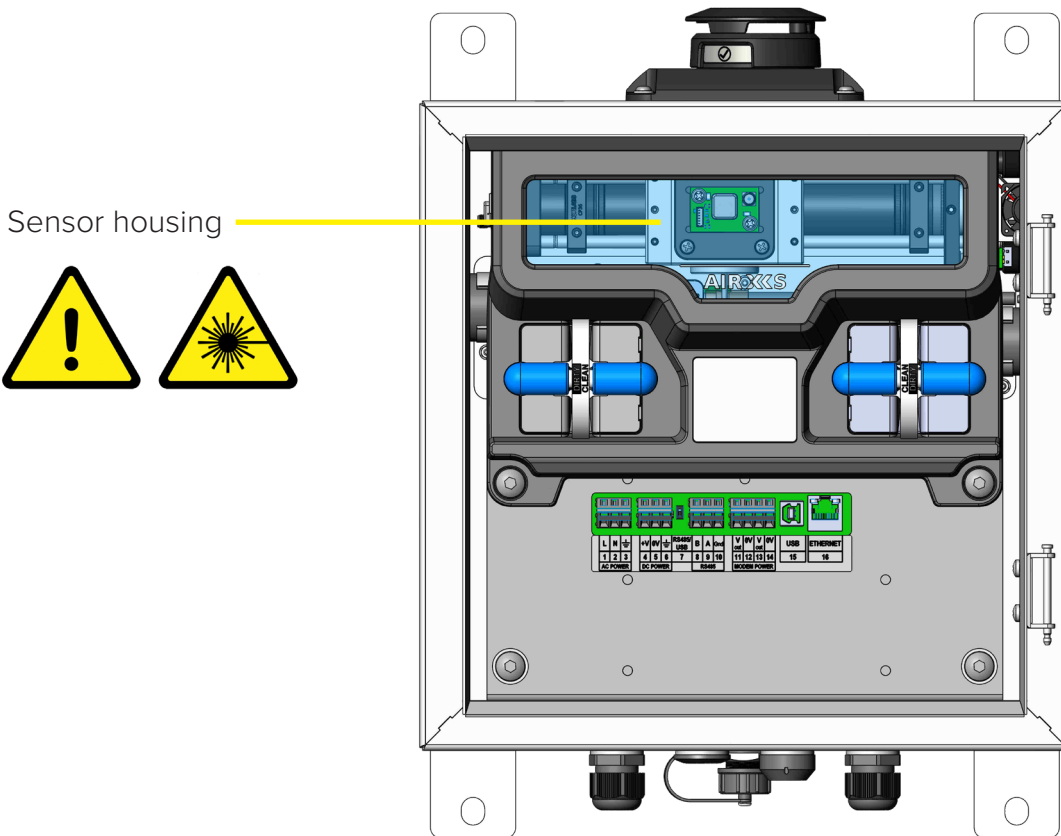

WARNING – There are no user-serviceable parts inside the Air XS unit. Servicing should only be carried out by Trolex or an approved service technician.

5. SYSTEM COMPONENTS

The Air XS is typically installed as a stand-alone instrument for general purpose applications. The instrument is supplied with peripherals fitted to allow for the 'plug and play' installation to universal mains/dc power supplies and data outputs.

The instrument and Trolex [BreatheXS](#) software are specifically designed to work in conjunction with each other using proprietary protocols and design features. The system has, however, been designed to support third-party power supplies and communication protocols where required.

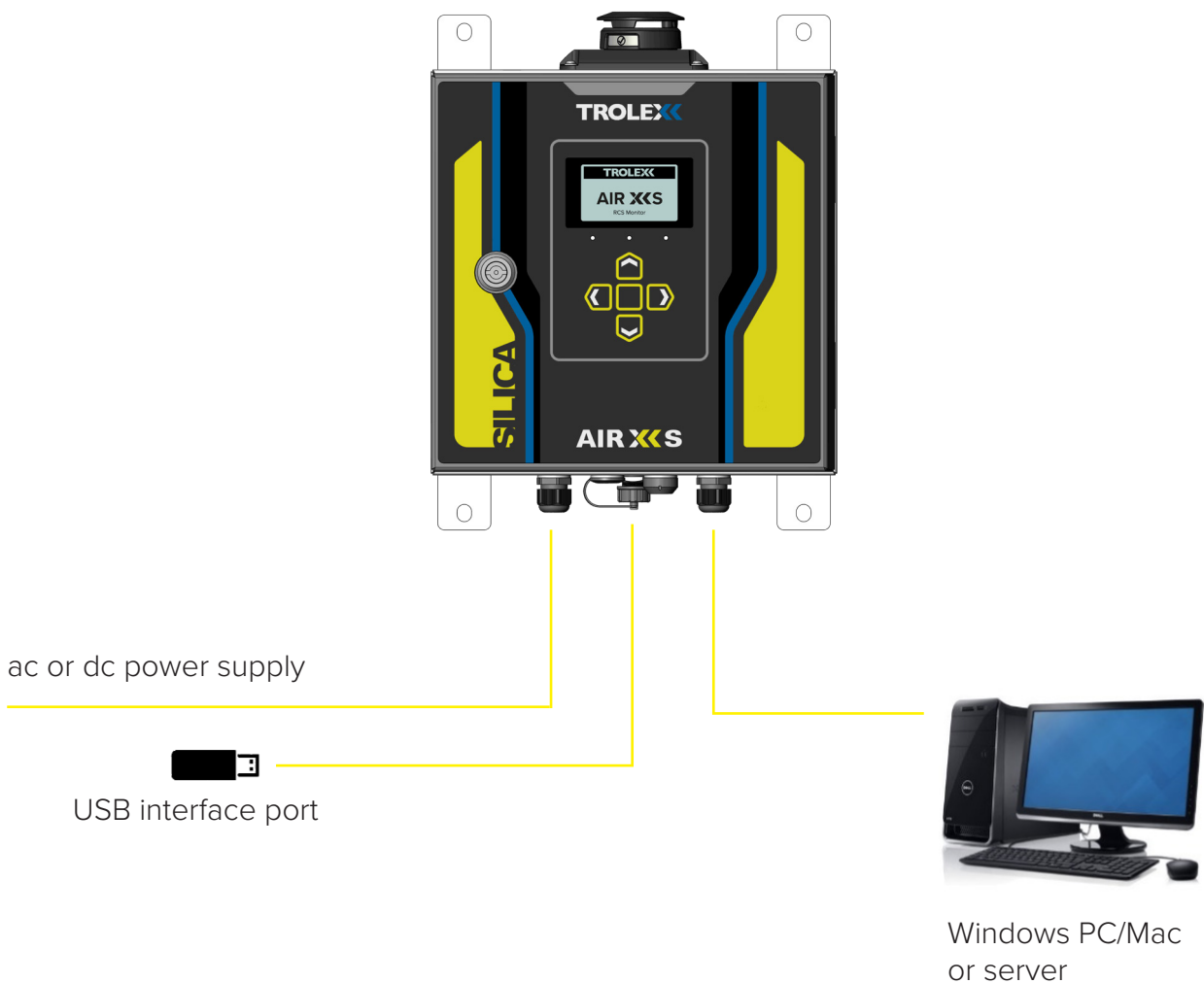

Example installation configuration

Note: M20 gland entries are provided for custom installation requirements. Gland entries may be blanked, and installations may vary from diagram shown.

5.1 TX8100 Air XS Silica Monitor

The Air XS Silica Monitor uses a custom particle sensor that is located inside a robust stainless-steel housing. This provides isolation and ingress protection between the particle flow path and the main control circuits. Control circuits are housed in a lockable, IP66 rated steel enclosure. Information and settings can be accessed using the keypad and display located on the front of the instrument.

The figure below shows the location of the navigation buttons, display screen and status LEDs. Power and network connections enter the main housing via cable entry glands located on the bottom of the instrument. The Air XS can be wall or stand mounted via the integrated external mounting brackets.

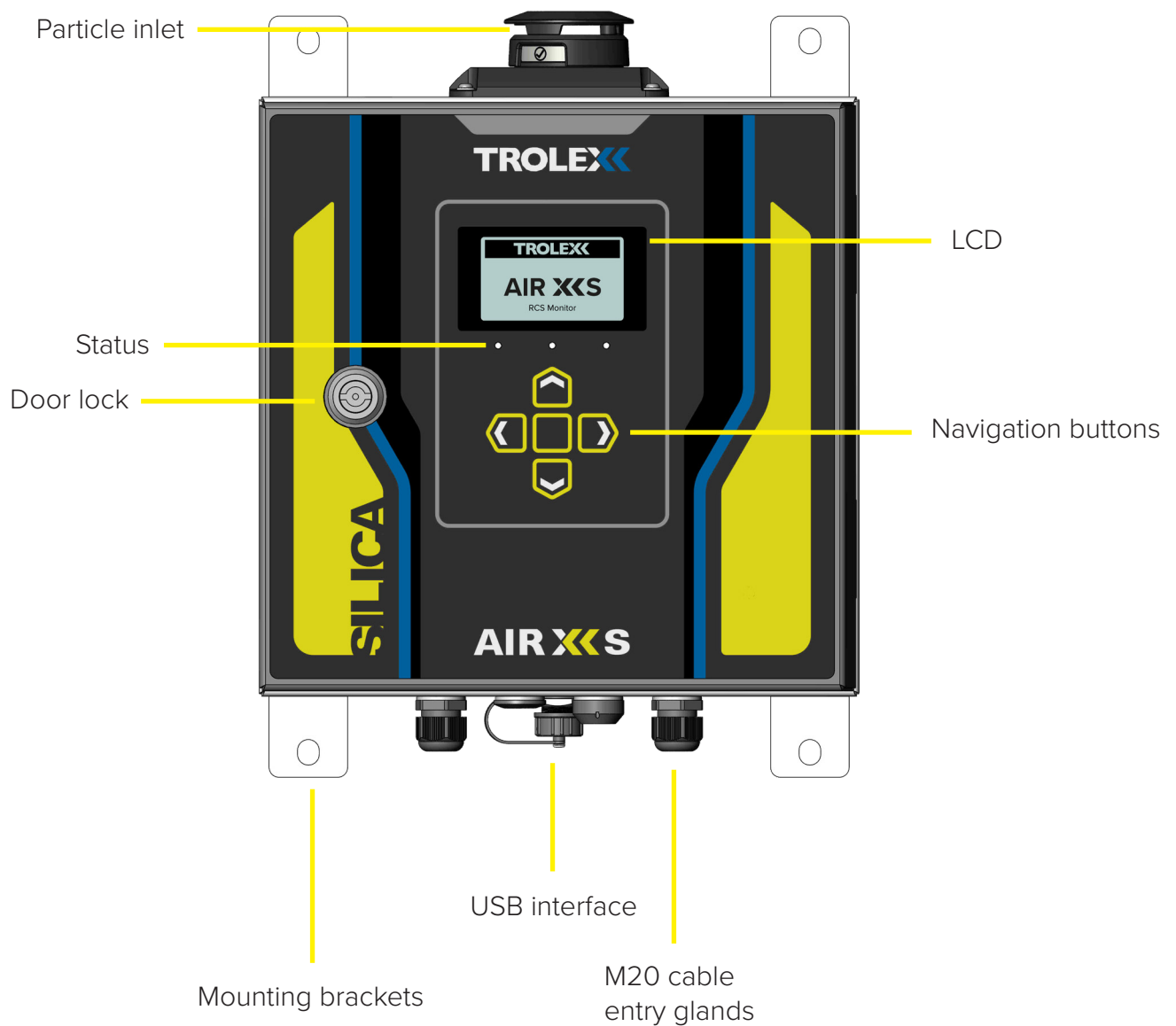

5.2 Particle flow path

The Air XS has been designed with the ability to restrict ingress through the particulate flow path during routine maintenance and cleaning periods. A rotational top cap is used to open or close the particle flow path to provide ingress protection during cleaning.

It is recommended that the top cap is set to the closed position during instrument maintenance and cleaning to ensure the dust sensor is not exposed to unnecessary ingress. When the top cap is rotated into the closed position, the Air XS conforms to IPX6.

Note: Rotate the top cap to move between 'open' and 'closed' positions.

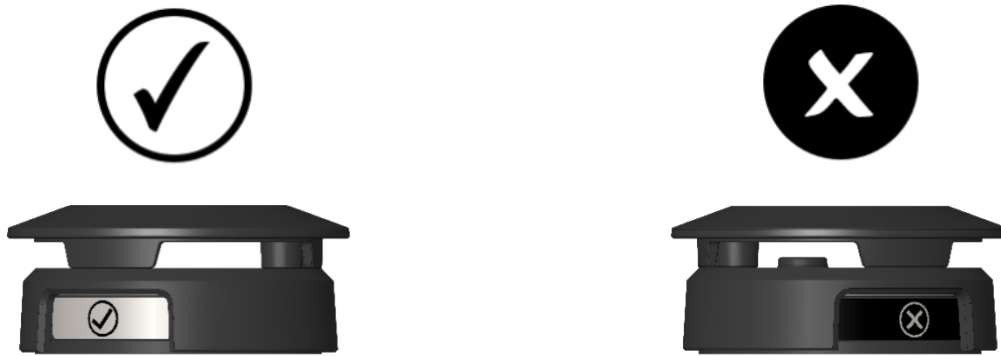

5.3 Peripherals and accessories

Power supply

The Air XS can be connected to a standard 100 V to 240 V ac power supply **or** a 9 to 18 V dc power supply. Before connecting a power supply to the instrument, ensure that the supply source is compatible with the instrument and information outlined on the appropriate rating plate.

See below for rating plate details.

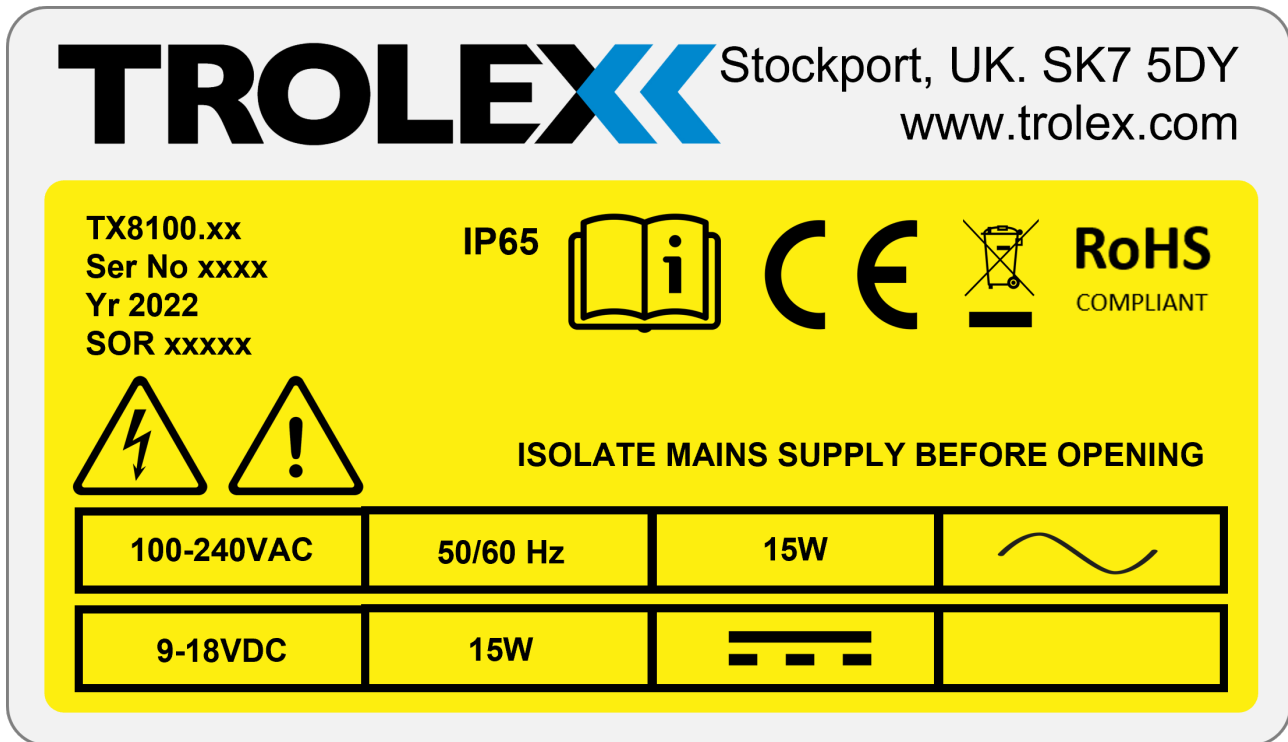

6. CERTIFICATION

6.1 Compliance



The Air XS complies with the following European Union Directives:

Electromagnetic Compatibility (EMC) Directive 2014/30/EU

- **EN 61326-1:2013**

Low Voltage Directive (LVD) 2014/35/EU

- **EN 61010-1:2010+A1:2019**

RoHS
COMPLIANT

The Air XS complies with the following RoHS Directives:

- **RoHS Directive 2002/95/EC**

- **RoHS 2 Directive 2011/65/EU**

7.1 Product specification

Particulate sensing parameters

Sensing technology	Optical refraction technology (ORT) Light-scatter photometer (OPC)
Particulate measurement	Target RCS identification range 1 to 10 μm
Max. typical dust loading*	150 mg/m^3
Continuous range	25 mg/m^3
Displayed data	RCS mg/m^3 Total particles/litre
Resolution	1,000 th of a mg
Averaging period	15 minutes, 1, 4, 8 and 12 hours (rolling average)
Sampling interval	1 to 60 seconds
Particle count	> 600 particles/second
Total airflow rate	~1.5 L/m (nominal)
Typical RCS accuracy	$\pm 25\%$

*The instrument can define particulate measurement peak trends up to the quantity specified.

Note: Sustained exposure to dust quantities above 25 mg/m^3 will be logged; however, it may affect the operating life of the Air XS sensor.

As applications of use are outside our control, the information provided is given without legal responsibility. Customers should test under their own conditions to ensure that the unit is suitable for their own requirements.

Technical specification

Operating temperature	-10 to 45 °C
Humidity	0 to 95% RH (non-condensing)
Housing material	PC/ABS – stainless steel
Ingress protection	Main enclosure: IP66 Particle flow path, cap open: IP22 Particulate flow path (cap closed): IPX6
Weight	8.2 kg
Cable entries	3 x M20 with removable blanks 1 x M20 breather gland 1 x M20 USB connector
Nominal power supply	100 to 240 V ac 50/60 Hz 9 to 18 V dc
Power consumption	15 W
Communications	RS485 data output with MODBUS RTU protocol Ethernet (MODBUS TCP/IP) - not implemented yet
External power output	2 x 15 V dc 1 A outputs (for powering external devices)
Connectivity	Troxel BreatheXS software
Data download	External USB interface
Instrument data storage	6 GB
User interface	128 x 64 dot matrix display with RGB backlight Navigation keypad (membrane)
Visual alarms	Custom alarm setpoints Latching/non-latching
Indicators	1 x green high brightness LED – sensor heartbeat 1 x blue high brightness LED – communications
Self-test routine	Sensor hardware, circuitry and communications on power on Manual self-test during use
Certification	CE compliant

7.2 Product dimensions

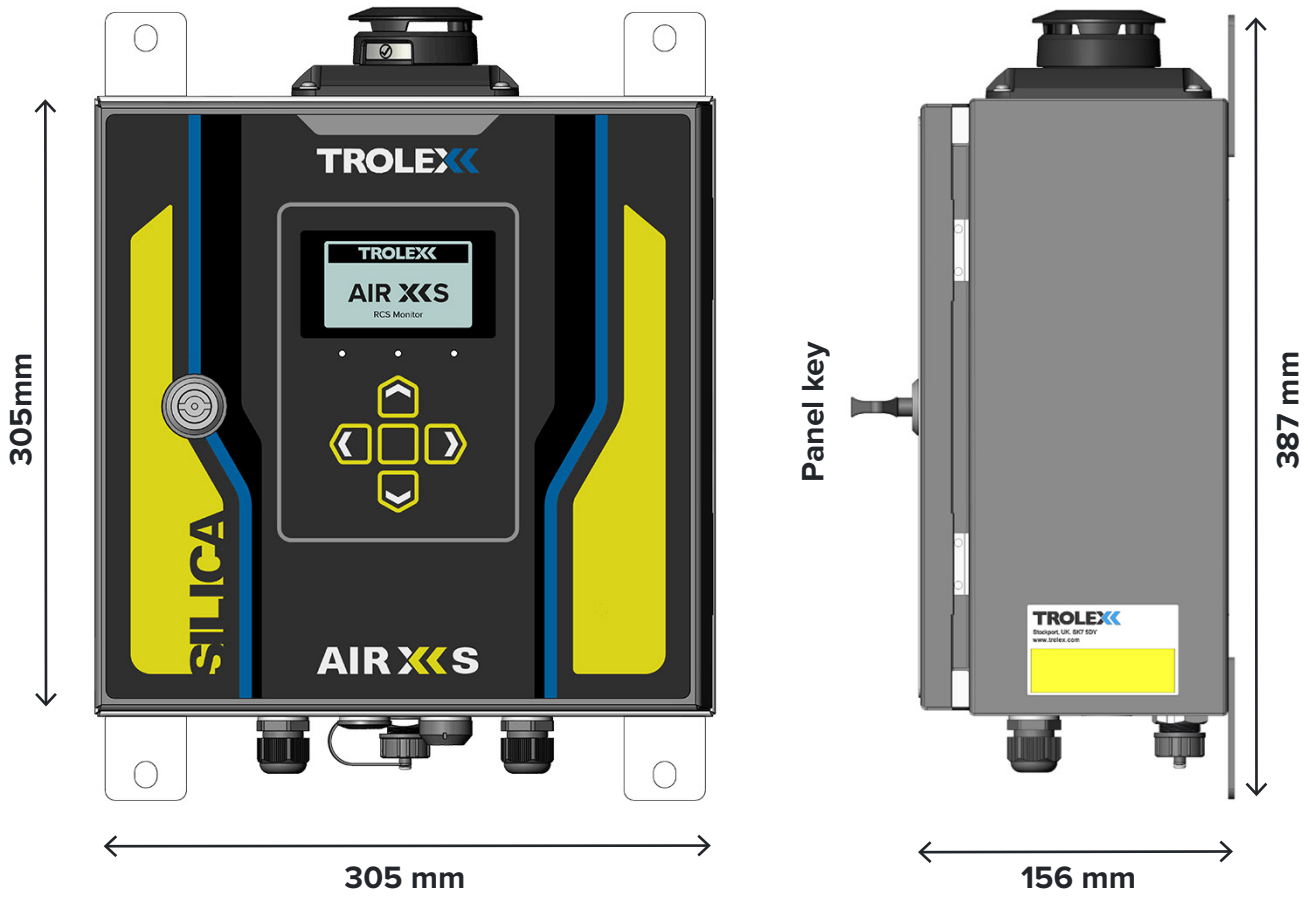

Note: Rotate the top cap to move between open and closed positions.

8.1 Safety precautions

Refer to **section 4** of this user manual before undertaking the installation of the Air XS device. The installation location of the Air XS device is the prerogative of the installer and care should be taken to ensure an appropriate position has been selected. Consider the location of a suitable power supply and external fuses, access to a communications network and the protection of cabling from damage.

1. Secure the Air XS to a suitable mounting surface using the integrated mounting brackets.
2. Ensure that the Air XS is mounted in an upright position.
3. Unlock and open the enclosure door to access the internals of the enclosure.
4. Ensure power is isolated before making electrical connections to the instrument.
5. Power supply voltage and frequency must match the instrument (refer to rating plate).
6. Ensure external switches or fuses are installed where applicable.
7. Run the required cables through the cable glands provided in the bottom of the enclosure.
8. Wire the cables into the relevant terminals as indicated on the internal plate (refer to **section 8.3**).
9. Tighten the cable gland against the cable to ensure an IP seal.
10. Close and lock the door after use to maintain IP rating of the enclosure.
11. Ensure that the particulate entry and exit ports are not restricted or covered.

Note: The instrument is susceptible to ingress when the door is **open** so care must be taken to ensure the location is clean during installation.

8.2 Mounting details

Note: Ensure the Air XS is mounted **vertically** during installation.



The figure and tables below detail the connections available internally in the Air XS. The connections can be accessed by opening the front housing of the instrument using the supplied key.

8.3 Electrical connections

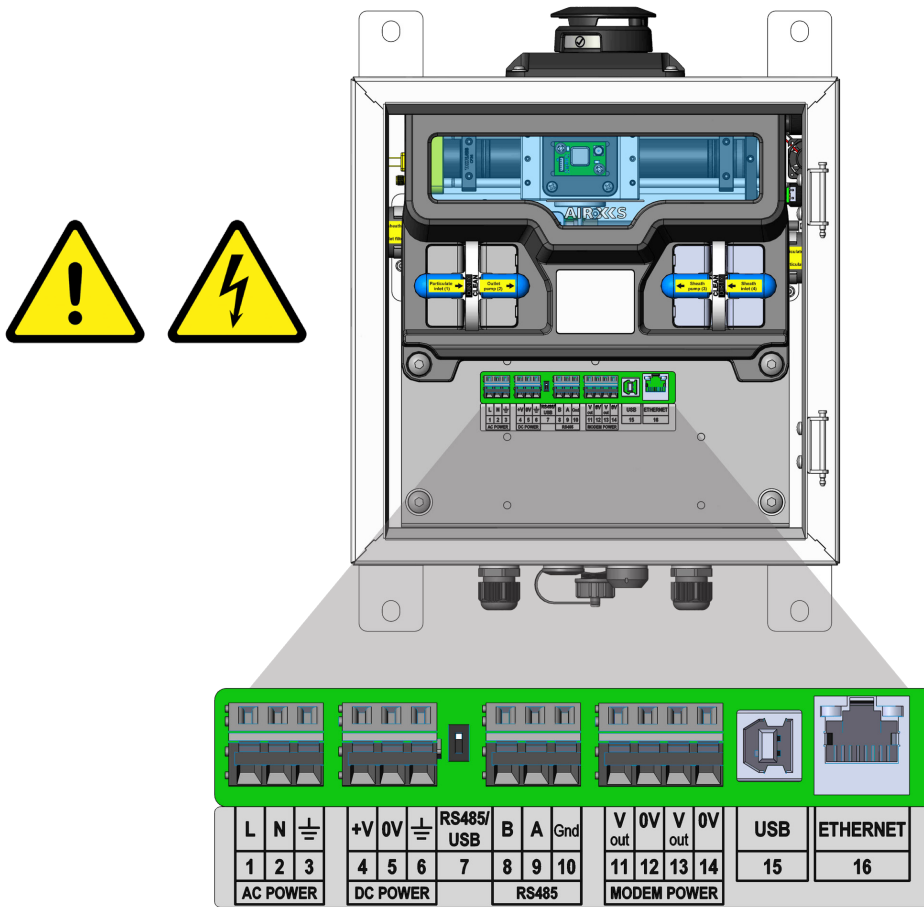

L	N	\perp
1	2	3
Power		

ac power

V+	0V	\perp
1	2	3
Power		

dc power

ac power in		dc power in		Outputs			
1	Live	4	Supply voltage	7	RS485/USB switch	11	V out
2	Neutral	5	0 V	8	RS485 B	12	0 V
3	Earth	6	Earth	9	RS485 A	13	V out
				10	RS485 0 V	14	0 V
						15	USB
						16	Ethernet

Table 1: Power, RS485, external power, USB and ethernet terminal connections.

8.4 I/O terminals

Power, RS485, 4 - 20 mA and relay connection terminal data is highlighted below.

Actuation type	Operating tool
Solid/stranded conductor	0.08 to 2.5 mm ² /28 to 12 AWG
Conductor with ferrule	0.25 to 1.5 mm ²
Strip length	5 to 6 mm/0.2 to 0.24 in

8.5 Power connections

For instruments connected to an ac power supply, it is the responsibility of the installer to ensure that the instrument is installed with the following protection:

- An external fuse or circuit breaker at a maximum of 5 A.
- Externally earthed.

See label below for details.



For instruments connected to a **dc power supply**, it is the responsibility of the installer to ensure that the instrument is installed with a dc supply, meeting re-enforced insulation requirements of **EN61010-1** or equivalent.

For instruments connected to an **ac power supply**, ensure that the equipment is protected by an external fuse or circuit breaker at a maximum of 5 A.

Once installed and powered for first time use, the Air XS will begin to monitor and sample the passing environmental particulates.

9.1 First power on

Prior to commissioning and first use, the instrument should be inspected for any visible damage and integrity of the enclosure.

1. Ensure that the electrical connections are correctly installed, as described in **section 8.3**.
2. Ensure that the door is closed and secured.
3. Apply power to the Air XS.
4. A splash screen will be displayed for several seconds whilst the instrument auto configures.
5. Once configuration is complete, the Air XS will automatically display on screen particle data.
6. Data is automatically logged to the internal memory for data download and offline analysis using the Trolex [BreatheXS](#) software.

9.2 System shutdown

1. Navigate to the main menu.
2. Scroll to the 'System Shutdown' menu selection.
3. Select "Confirm" to begin the system shutdown procedure.

Following this, the device will shut down and the power supply can be safely disconnected.

Note: Before disconnecting power to the Air XS unit, it is recommended that the system shutdown procedure is followed correctly. This is to ensure that the onboard operating system and data capture integrity remains stable.

9.3 Application software

The Trolex [BreatheXS](#) software is available for download and installation from the Trolex website and is specifically designed for the import and review of data sets collected by the Air XS instrument.

Note: The Trolex [BreatheXS](#) software **is not** required for general Air XS operation.

10.1 Navigation

The Air XS user interface is controlled and navigated using the on-device keypad and display. The keypad consists of four directional keys and a central enter key to allow the scrolling, selection and input of data into the instrument.

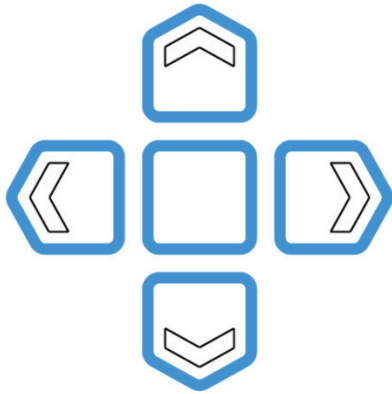

Directional keypad



User interface



Up navigation key



Down navigation key



Down navigation key



Enter key

11.1 User interface display

On initial power up of the Air XS, particulate sampling will automatically start, and the graphical display will show the following screens. Once the instrument has been auto-configured, the Air XS will begin sampling the environmental dust mixtures.

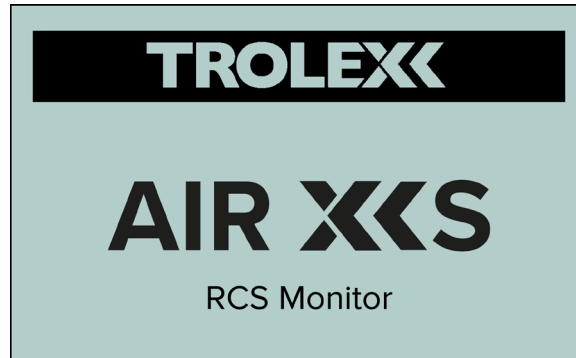

Title screen

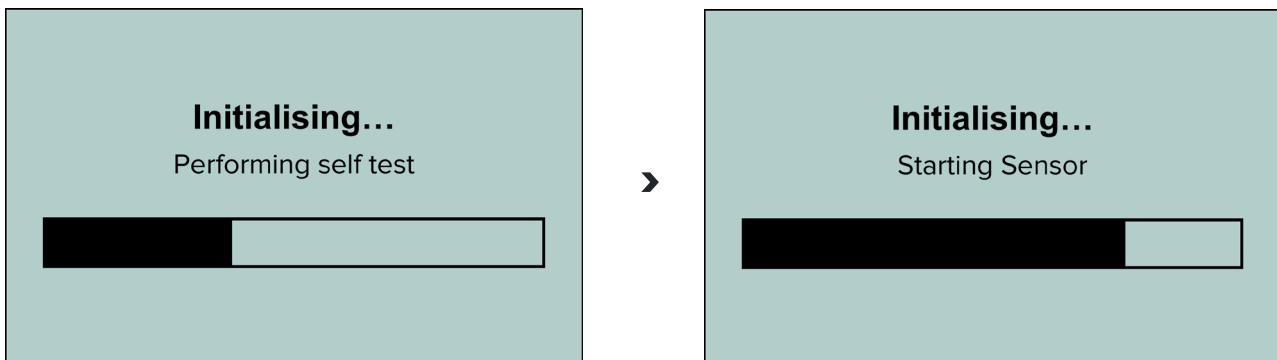

Device installation

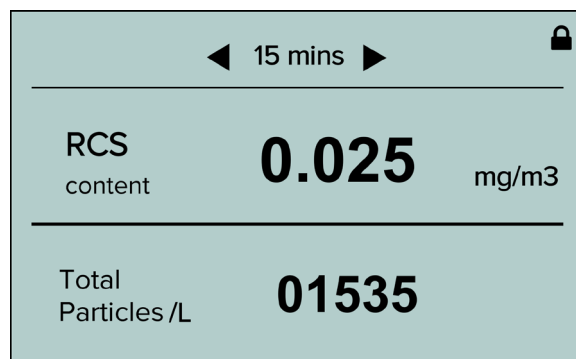

Particle information
(Default landing screen)

11.2 Particulate display information

The following information is presented on the Air XS display during particle sampling and operation.

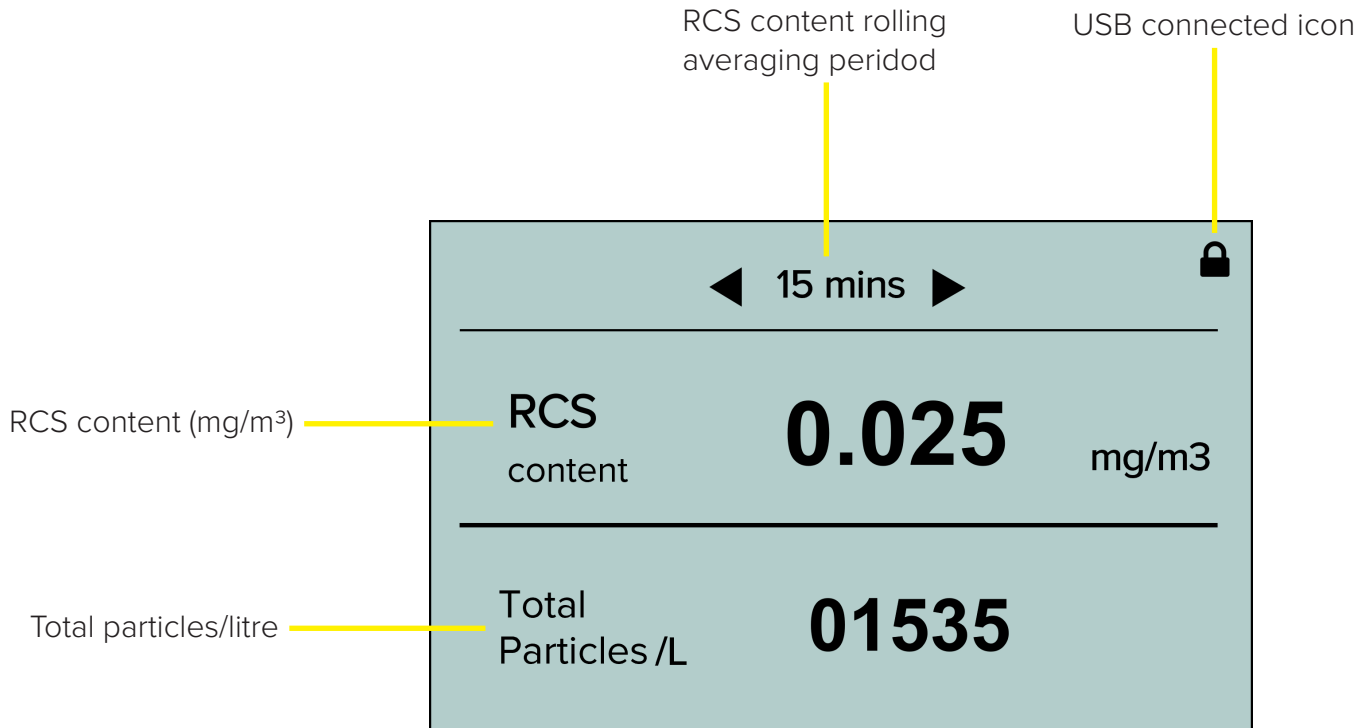

11.2.1 Data capture format

During normal operation the Air XS will capture the associated function data and generate a single log file for the relevant time span – this typically results in one file a day.

Note: If the Air XS is restarted, a new file will be generated and saved for the associated period.

11.2.2 Data download

The Air XS allows users to download collected data sets via the 'data download' menu. Data is stored on the instrument internal memory and can be locally downloaded onto a removable USB device when connected via the external USB connector positioned on the bottom face of the instrument.

Note: We recommend using a USB device with a minimum storage capacity of 8GB for local data download. The Air XS only supports **FAT32** file formatted USB devices.

Collected data can be retrieved from the Air XS instrument by selecting the 'USB Download' function from the download menu.

Data download functionality is only available when a remote USB drive is connected to the Air XS. If the USB drive is removed from the Air XS during a download operation, the sequence will be interrupted, and the unit will require restarting before continuing with a data download.

Note: Depending on the overall size of the data collected by the Air XS, remote data download can take several minutes to complete.

12.1 Default settings

The Air XS has been programmed with factory default settings prior to delivery which are detailed in the table below.

RCS averaging period	15 minutes, 1, 4, 8 and 12 hours (rolling average) <i>user selectable</i>
Display units	mg/m ³ (for the selected rolling average period) Total particles/litre
RS485 baud rate	N/A
RS485/Modbus	N/A
Ethernet	N/A
Alarms	Disabled
Alarm thresholds	Deactivated
Alarm channel	15 minutes
Alarm latching	Disabled

12.2 On-site configuration

The Air XS instrument is designed not to require any specific user configuration beyond the following alarm parameters.

12.3 Custom alarms

The Air XS has a single-user configurable alarm that can be used to warn users of a specific particulate threshold breach based on a chosen limit or value.

To enable the alarm functionality, follow the sequence outlined below.

1. Navigate to the 'Main Menu'
2. Select the 'Alarms' function from the list
3. The 'Detail' function will provide an overview of any pre-set alarms and threshold values
4. Select 'Configure' to assign an alarm to the following parameters
 - a. Channel (averaging period)
 - b. Value (threshold)
 - c. Mode (latching/non-latching)
 - d. Units (mg/m³)

Note: To save the changes to the alarm function, exit the menu using the left arrow key, which will prompt a 'Settings saved' dialogue box. To exit the alarm function menu without saving any changes, just allow the menu to time out.

12.4 External audio-visual (AV) alarm set-up

Air XS contains two programmable alarm outputs, which allow for powering an external AV Alarm or a relay. Each output can be programmed with its own set-point, and can be configured for normally on/normally off operations.

The outputs can deliver a total current of 1.2 A and are internally protected by a resettable 2 A fuse. If Air XS is powered from a main power source (100 to 265 V ac), then the output voltage on the alarm terminals is 15 V dc.

If Air XS is powered from a dc source, then the output voltage of the alarms will be equal to the voltage at the dc power terminals.

An option is also included to permanently power the output to essentially allow for powering an external modem.

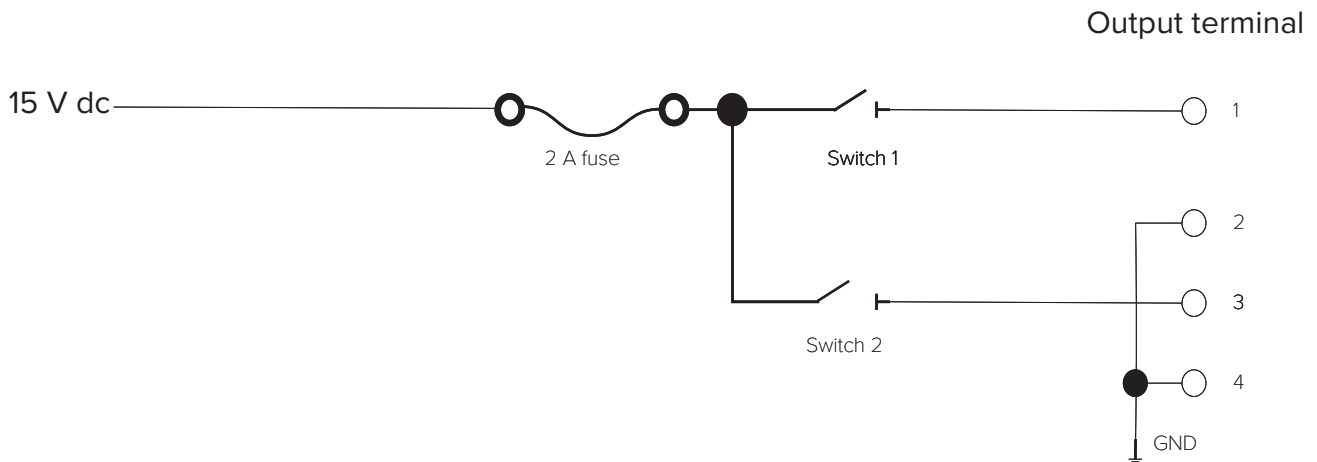

Equivalent circuit if powered from a mains voltage.

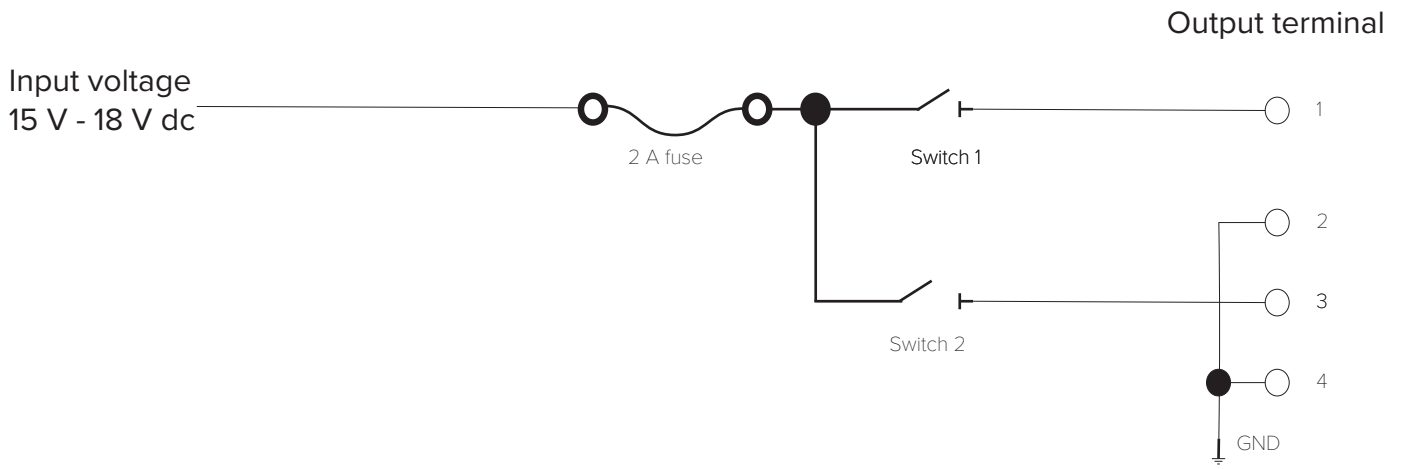

Equivalent circuit if powered from a dc voltage.

13. UPDATING UNIT FIRMWARE

On notification of firmware update and release, the Air XS can be updated via the on-device firmware update functionality. The instrument requires the update to take place via the connection of an external USB device loaded with the latest firmware.

Note: A detailed set of instructions for updating the unit is available from Trolex Ltd. Instrument firmware updates should only take place on notification and release from Trolex or an approved distribution partner.

14. MAINTENANCE

The maintenance of the Air XS must only be carried out by competent personnel. Maintenance shall be considered with reference to the local safety regulations, authorities, and guidelines.

14.1 Visual checks

Periodic visual checks should be carried out to assess if there are any issues arising with the Air XS instrument. Check for the following.

1. External damage to the instrument. Plastic parts should not be cracked or broken which could affect the IP rating of the instrument.
3. Internal or external damage to wiring that is connected to the Air XS instrument.
4. Labels on the instrument are still in place and are not peeling or discolouring.

14.2 Cleaning labels

It is recommended to periodically clean the instrument with a damp cloth, to ensure the display, keypad and rating labels are clean and legible.

14.3 Particulate entry/exit apertures

The particulate exit aperture is protected by a stainless-steel grille to minimise the ingress of flora and fauna into the Air XS instrument. It is recommended that the grille is checked and cleaned during maintenance periods to ensure that it has not become clogged with ingress that may obscure the particulate sensing airflow.

It is important to ensure that the particle top cap inlet is periodically checked for obstruction or blockages caused by particle build up or settling.

14.4 Filter replacement

The Air XS uses two HEPA inlet and outlet filters for the purpose of providing a clean sample air flow within the device. It is recommended that these filters are replaced every month to maintain the performance of the device.

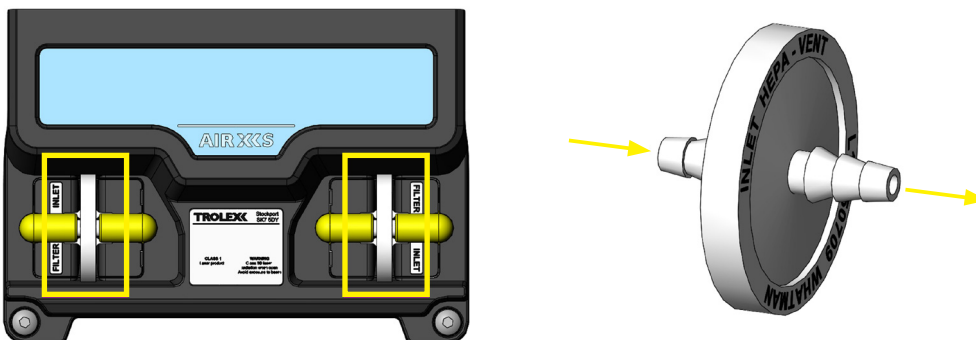

When replacing the HEPA filters, be sure to observe the flow direction specified and ensure it matches that specified on the Air XS filter cover plate.

To replace the HEPA filters, follow the steps below:

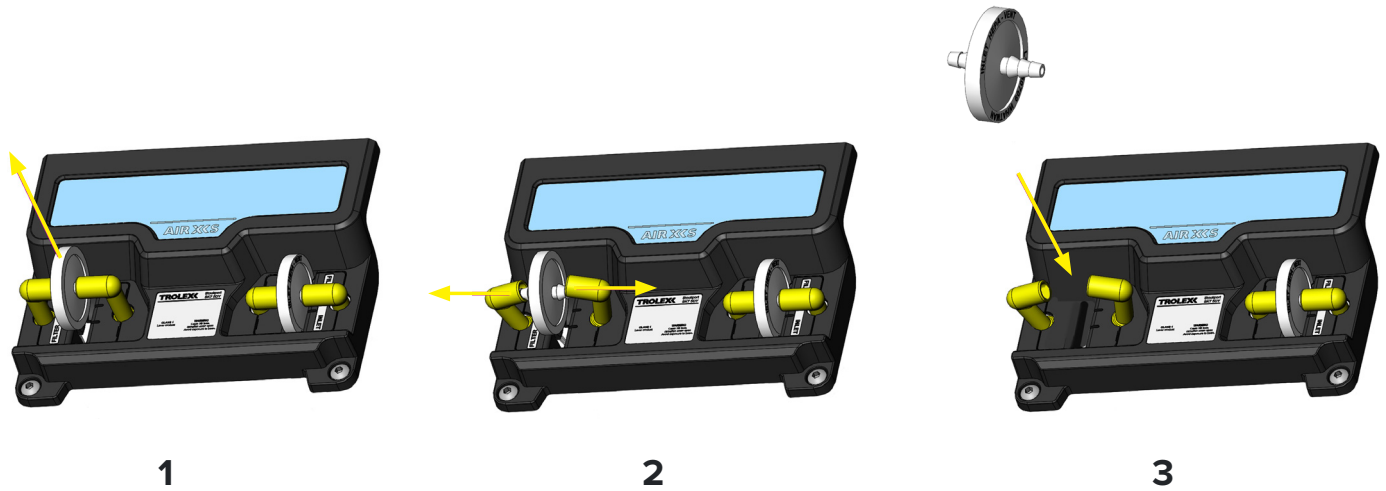

1. Pull up the filter cartridge to free it from the filter cover plate.
2. Remove the filter adapters from each side of the filter cartridge and remove.
3. Replace the filter cartridge with the new part, taking care to correctly orientate the flow direction.

14.5 Warranty

All Air XS products and accessories will come with a 12-month warranty.

Note: Air XS products that do not undergo monthly compliance checks will not be covered by the 12-month warranty.

The following sections detail and contain information to assist with the troubleshooting of instrument functionality if required. If an issue is non-resolvable based on the information below, please contact the Trolex product support team.

15.1 High temperature operating

The Air XS operates a protective thermal cut-out sequence when the temperature inside the instrument exceeds the maximum operating temperature specification, detailed in **section 7**. This protective measure is in place to maintain the lifespan and operating functionality of the optical sensor assembly when the Air XS is installed in environments with high ambient temperatures.

15.2 Fault codes

The following codes relate to on-screen warnings that the Air XS will display when a fault is encountered during normal operations.

Code	Fault name	Fault description	Fault check
1	Top cap closed	The particle inlet top cap is closed and will not allow particles to flow into the device.	Check top cap position and move to open.
3	Blockage error	The Air XS has detected that the silica filters are blocked.	Replace internal HEPA filters.
4	Laser fault	A laser anomaly has been detected.	Contact Trolex for advice.
5	Storage full	The Air XS internal memory is at 100% capacity and requires erasing.	Erase internal memory via 'Data Download' menus.

16. GLOSSARY AND DEFINITIONS

Air XS_User manual_P5633.1601_ Rev F

Flow rate	The volume of air mixture which passes per unit time
Particles/litre	Particles per litre of air that passes through the sensing element
IP	Ingress protection
$\mu\text{g}/\text{m}^3$	Microgram per metre cubed. The concentration of an air pollutant given in micrograms (one-millionth of a gram) per cubic metre of air
mg/m^3	Milligram per metre cubed. The concentration of an air pollutant given in milligrams (one-thousandth of a gram) per cubic metre of air
OPC	Optical particulate counter
ORT	Optical refraction technology
Particulate matter (PM)	General term for a mixture of solids and liquid droplets suspended in the air from typical processes including combustion, industrial activities or natural sources
PM_x	PM_x is particulate matter x micrometer or less

17.1 Waste of Electrical and Electronic Equipment (WEEE) Directive (2012/19/EU)

The Air XS operates a protective thermal cut-out sequence when the temperature inside the instrument exceeds the maximum operating temperature specification, detailed in **section 7**. This protective measure is in place to maintain the lifespan and operating functionality of the optical sensor assembly when the Air XS is installed in environments with high ambient temperatures.

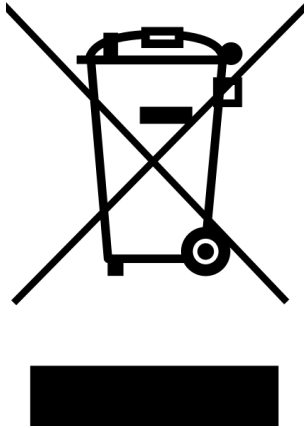

This symbol, if marked on the product or its packaging, indicates that this product must not be disposed of with general household waste.

In the European Union and many other countries, separate collection systems have been set up to handle the recycling of electrical and electronic waste.

At the end of the product's life, do not dispose of any electronic sensor, component or instrument in the domestic waste. Contact Trolex or the distributor for disposal instructions.

18. GET IN TOUCH

18.1 Technical support

Our UK technical services team are available to provide expert ongoing technical assistance and technical support packages tailored to your specific requirements.

Please contact our technical services team:

Telephone: [+44 \(0\)161 483 1435](tel:+44(0)1614831435)

Email: service@trolex.com

18.2 Feedback

If you have any suggestions for improvements or amendments, or find errors in this publication, you can contact marketing@trolex.com directly.

DISCLAIMER

The information provided in this document contains general descriptions and technical characteristics of the performance of the product. It is not intended as a substitute for and is not to be used for determining suitability or reliability of this product for specific user applications. It is the duty of any user or installer to perform the appropriate and complete risk assessment, evaluation and testing of the products with respect to the specific application or use. Trolex shall not be responsible or liable for misuse of the information contained herein. When instruments are used for applications with technical safety requirements, the relevant instructions must be followed.

All pertinent state, regional, and local safety regulations must be observed when installing and using this instrument. For reasons of safety and to help ensure compliance with documented system data, only Trolex or its affiliates should perform repairs to components.

Trolex Ltd. reserves the right to revise and update this documentation from time to time without obligation to provide notification of such revision or change. Revised documentation may be obtainable from Trolex.

Trolex Ltd. reserves the right, without notice, to make changes in equipment design or performance as progress in engineering, manufacturing or technology may warrant.

TRADEMARK

© 2023 Trolex® Ltd.

No part of this document may be reproduced in any form or by any means, electronic or mechanical, including photocopying, without express written permission of Trolex.

Trolex is a registered trademark of Trolex Ltd. The use of all trademarks in this document is acknowledged.

At Trolex, we save lives.

We believe that no person should risk their life to earn a living.

Our aim is to become the world's leading name in health and safety technology, through pioneering products that provide real-world benefits to our customers, whenever workers operate in hazardous environments.

For more information about Trolex, please contact us at:

Enquiries

sales@trolex.com

Telephone

+44 (0) 161 483 1435

Fax

+44 (0) 161 483 5556

Trolex Ltd

Newby Road, Hazel Grove
Stockport, Cheshire
SK7 5DY, United Kingdom

Website

www.trolex.com

